

WEATHERTEX CONSTRUCTION DETAIL GUIDE

WEATHERGROOVE PANELS

9.5mm CAVITY CONSTRUCTION

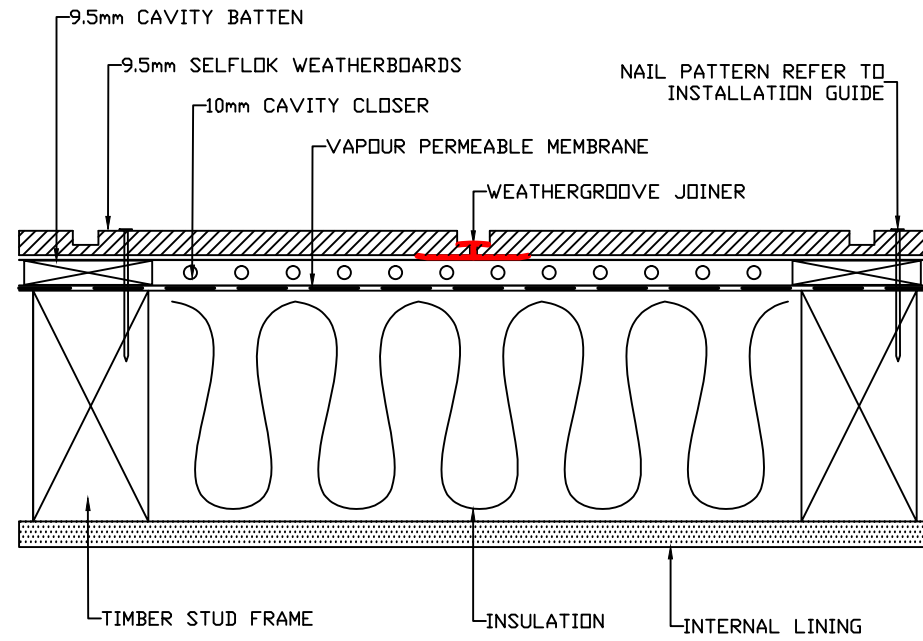



OFF STUD WEATHERGROOVE JOINER DETAIL

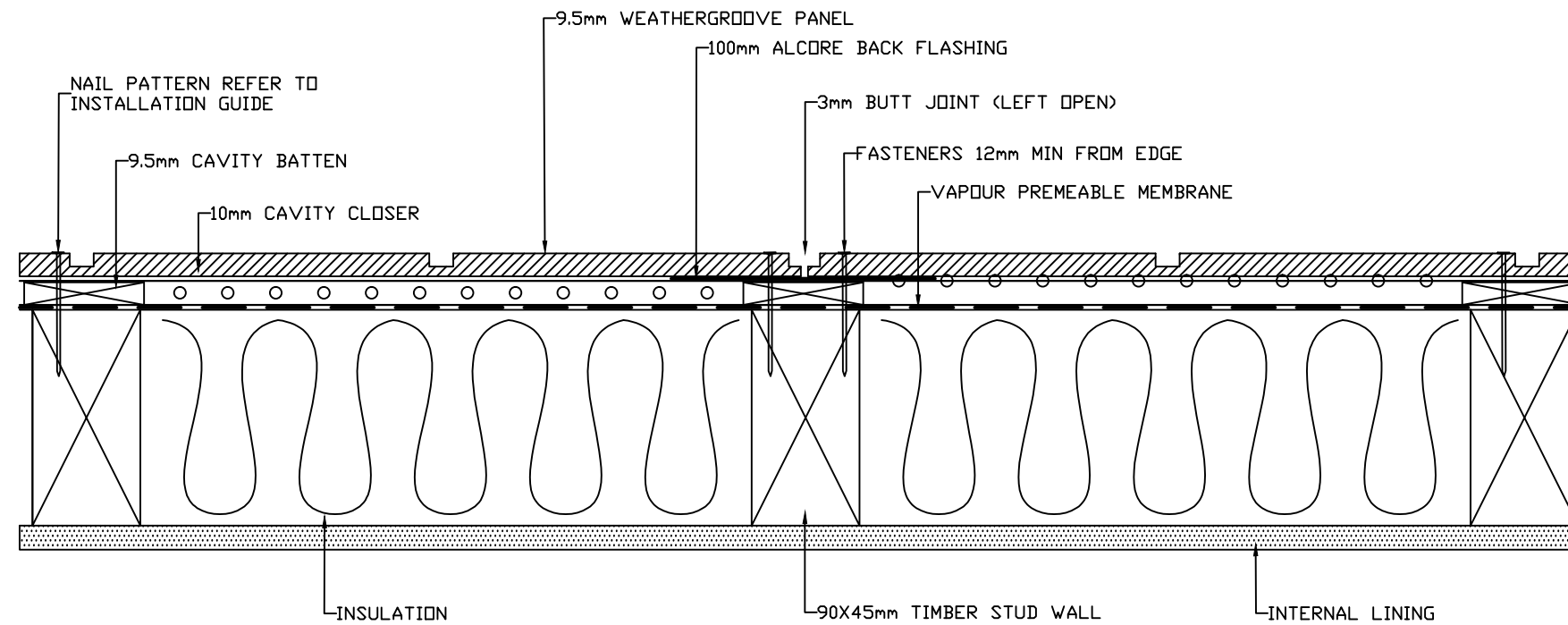

ON STUD BUTT JOIN DETAIL



DRAWING NAME:

9.5mm CAVITY INSTALLATION - WEATHERGROOVE

SCALE:

NTS

DRAWN BY:

A.MOATE

CHECKED BY:

C.O'NEILL

DATE:

26.10.17

DRAWING SET No.:

CD-WG-C

SHT SIZE

A3

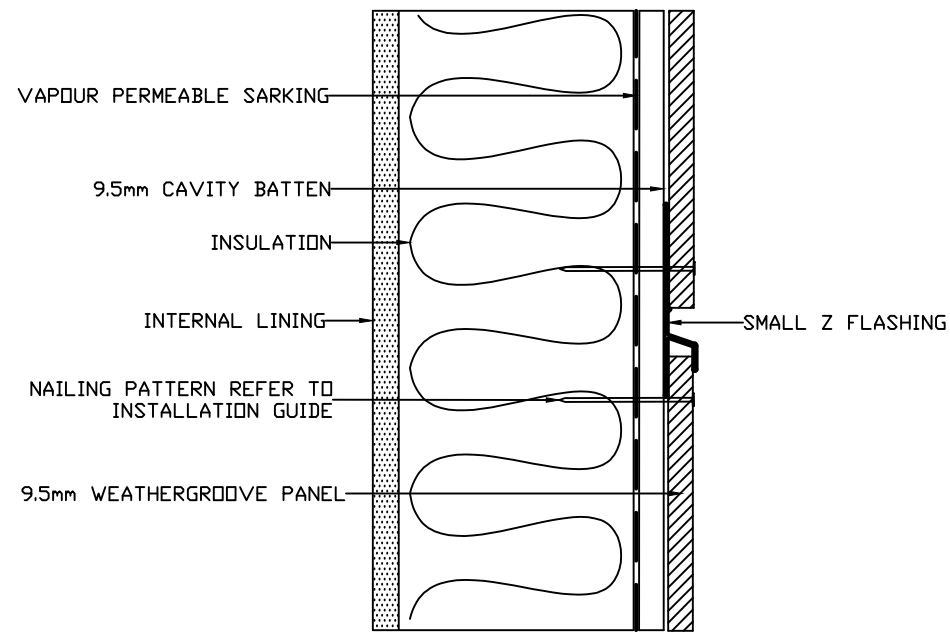

SMALL Z FLASHING JOIN DETAIL

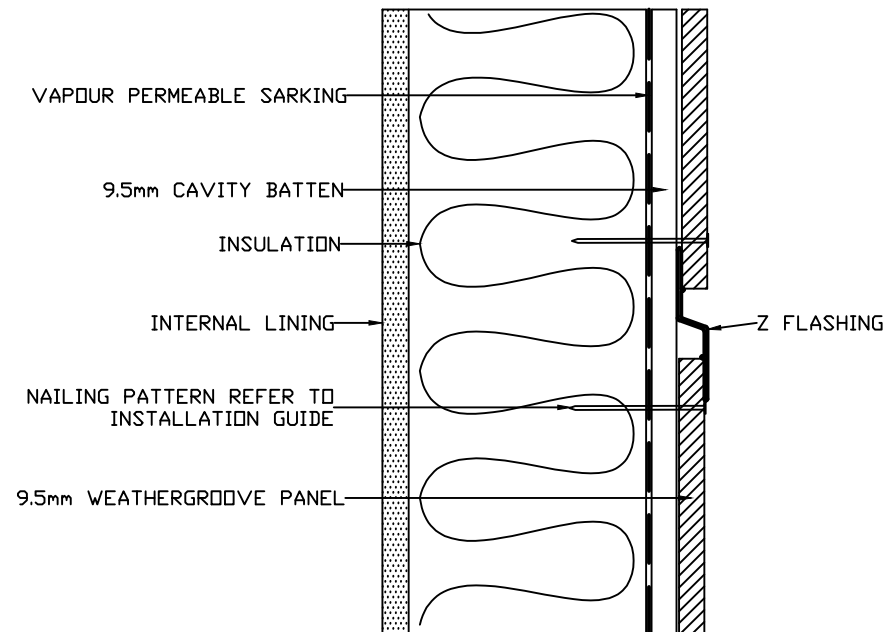

Z FLASHING JOIN DETAIL

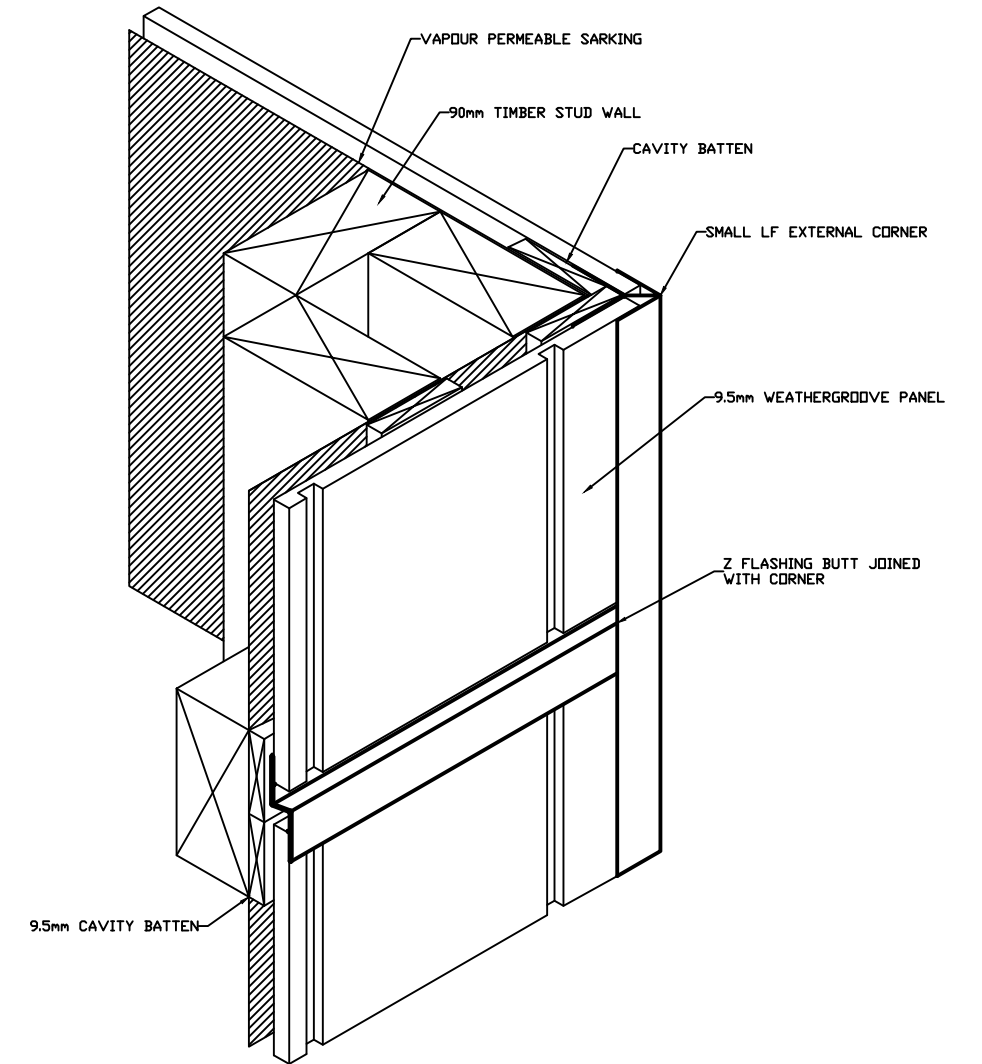

Z FLASHING INTO CORNER DETAIL



DRAWING NAME:
9.5mm CAVITY INSTALLATION - WEATHERGROOVE

SCALE:
NTS

DRAWN BY:
A.MOATE

CHECKED BY:
C.O'NEILL

DATE:
26.10.17

DRAWING SET No.:
CD-WG-C

SHT SIZE
A3

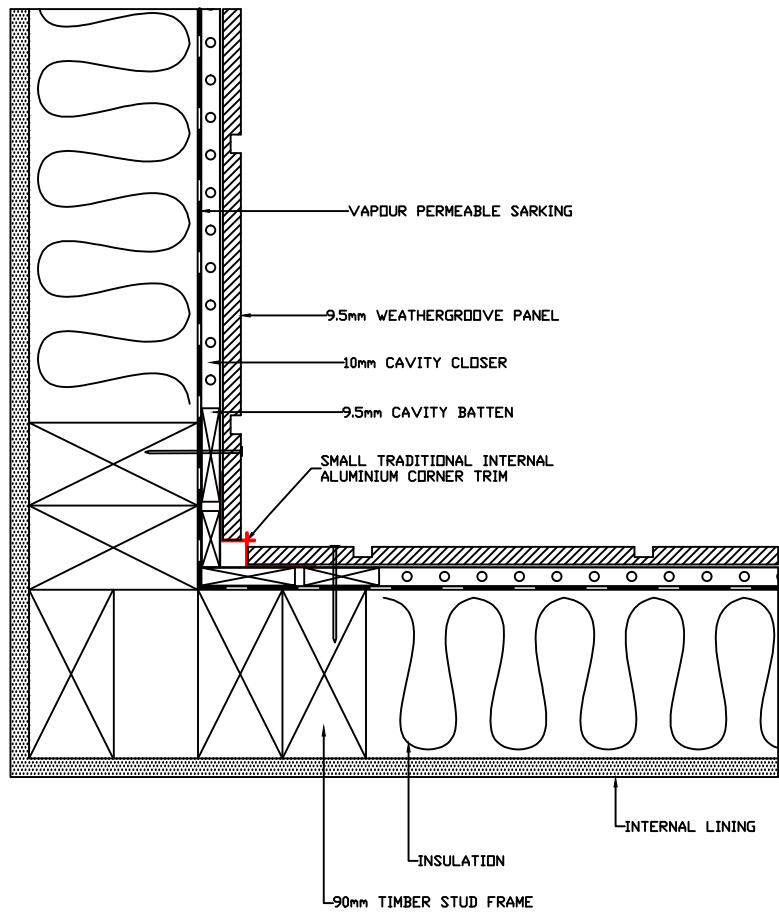

SMALL TRADITIONAL INTERNAL "W" CORNER DETAIL

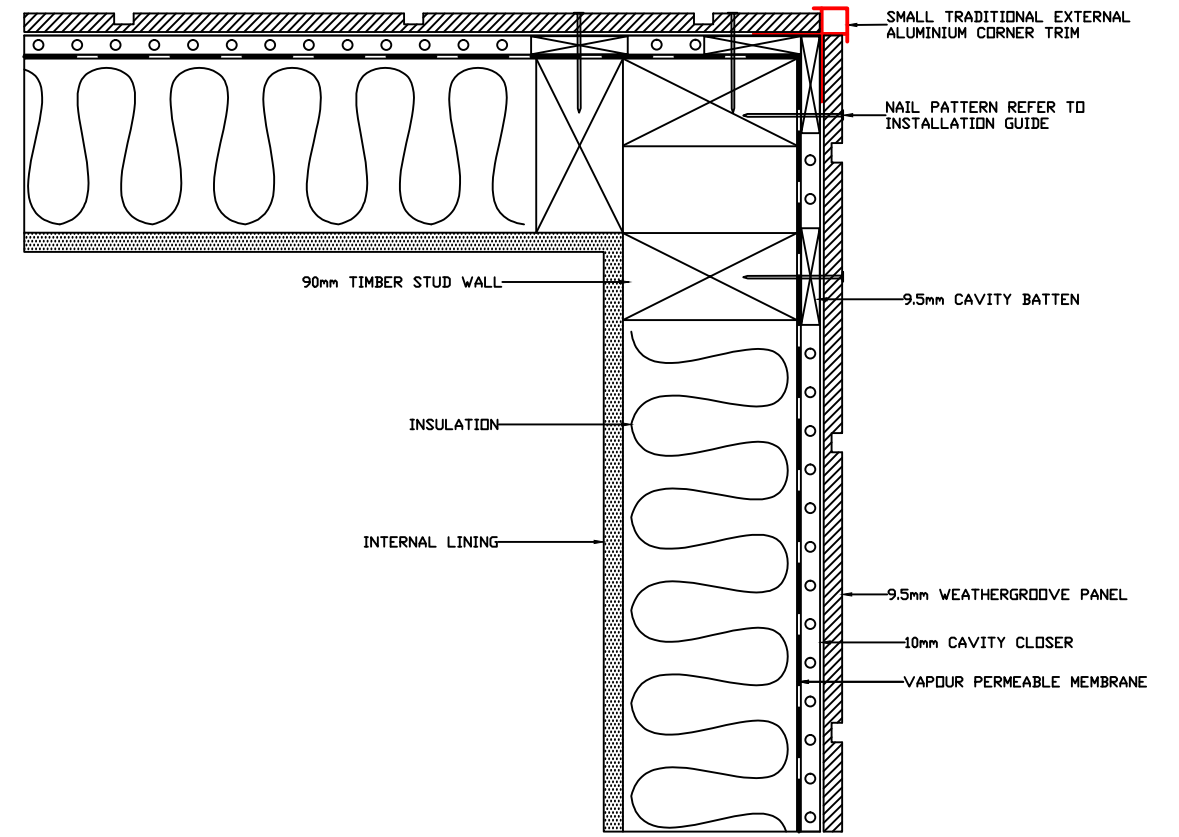

SMALL TRADITIONAL EXTERNAL "BOX" CORNER DETAIL

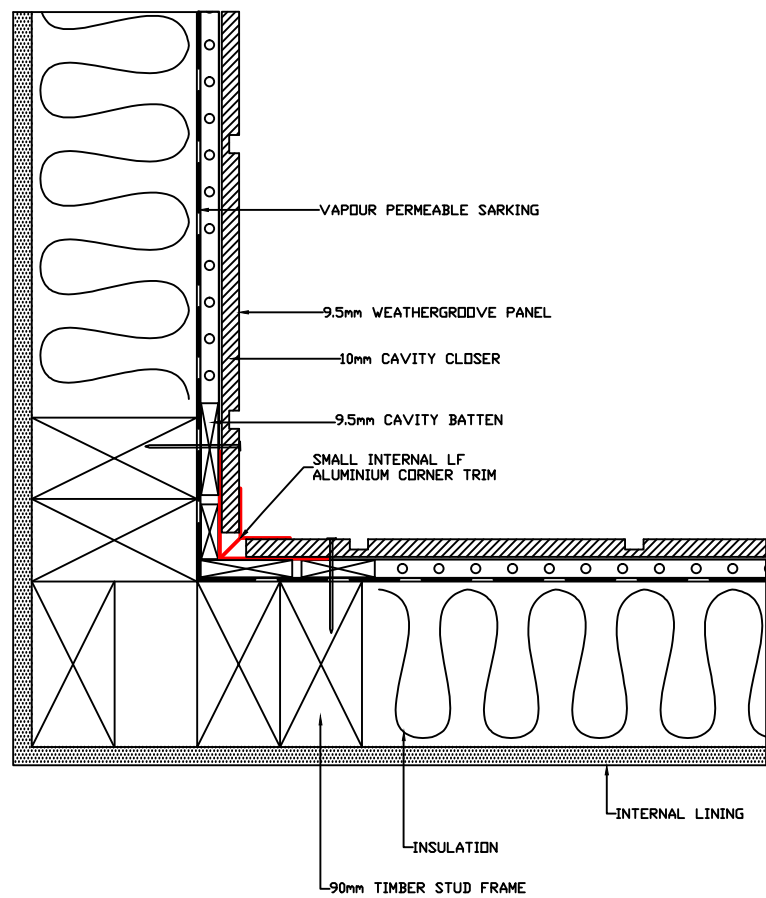

SMALL INTERNAL LF CORNER DETAIL

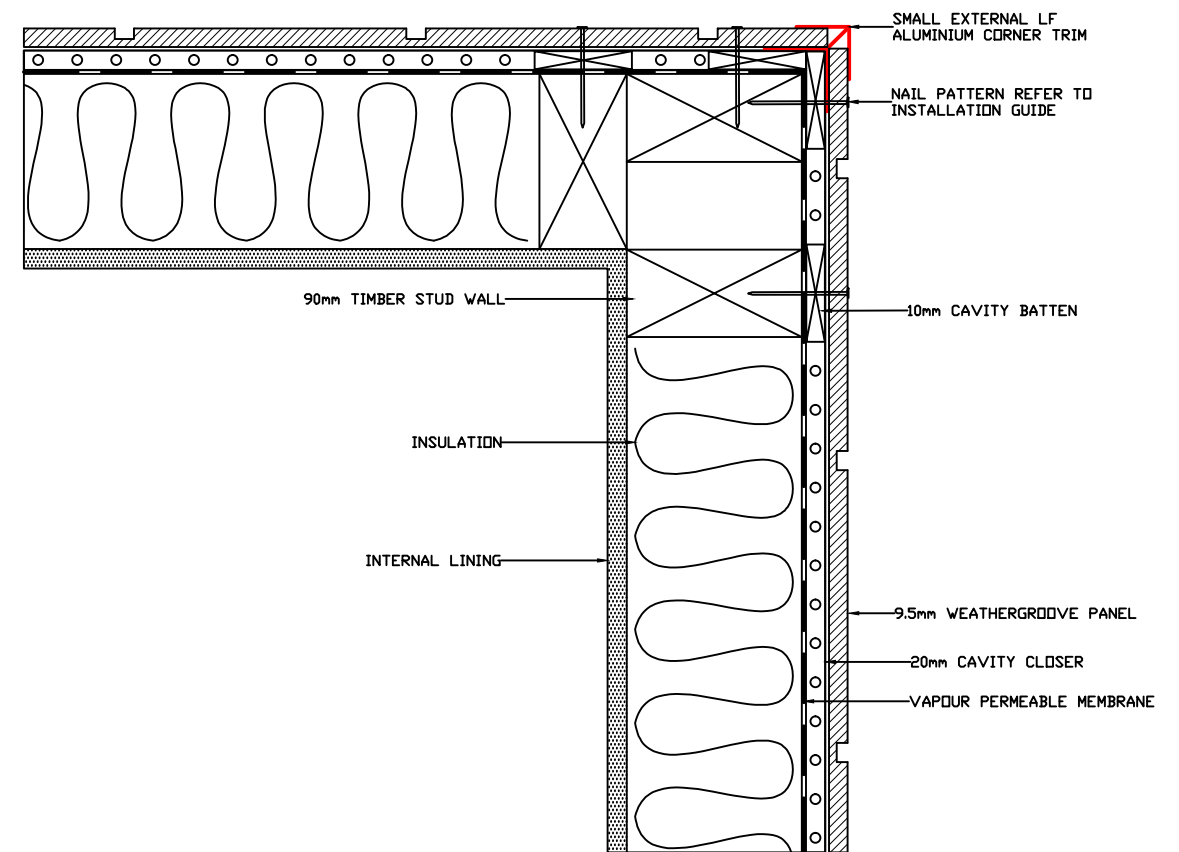

SMALL EXTERNAL LF CORNER DETAIL



DRAWING NAME:
9.5mm CAVITY INSTALLATION - WEATHERGROOVE

SCALE:
NTS

DRAWN BY:
A.MOATE

CHECKED BY:
C.O'NEILL

DATE:
26.10.17

DRAWING SET No.:
CD-WG-C

SHT SIZE
A3

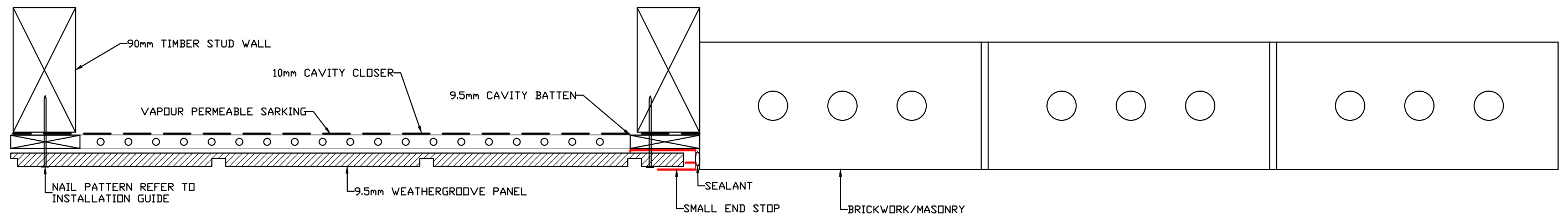

END STOP TO MASONRY BRICK DETAIL



DRAWING NAME:

9.5mm CAVITY INSTALLATION - WEATHERGROOVE

SCALE:

NTS

DRAWN BY:

A.MOATE

CHECKED BY:

C.O'NEILL

DATE:

26.10.17

DRAWING SET No.:

CD-WG-C

SHT SIZE

A3

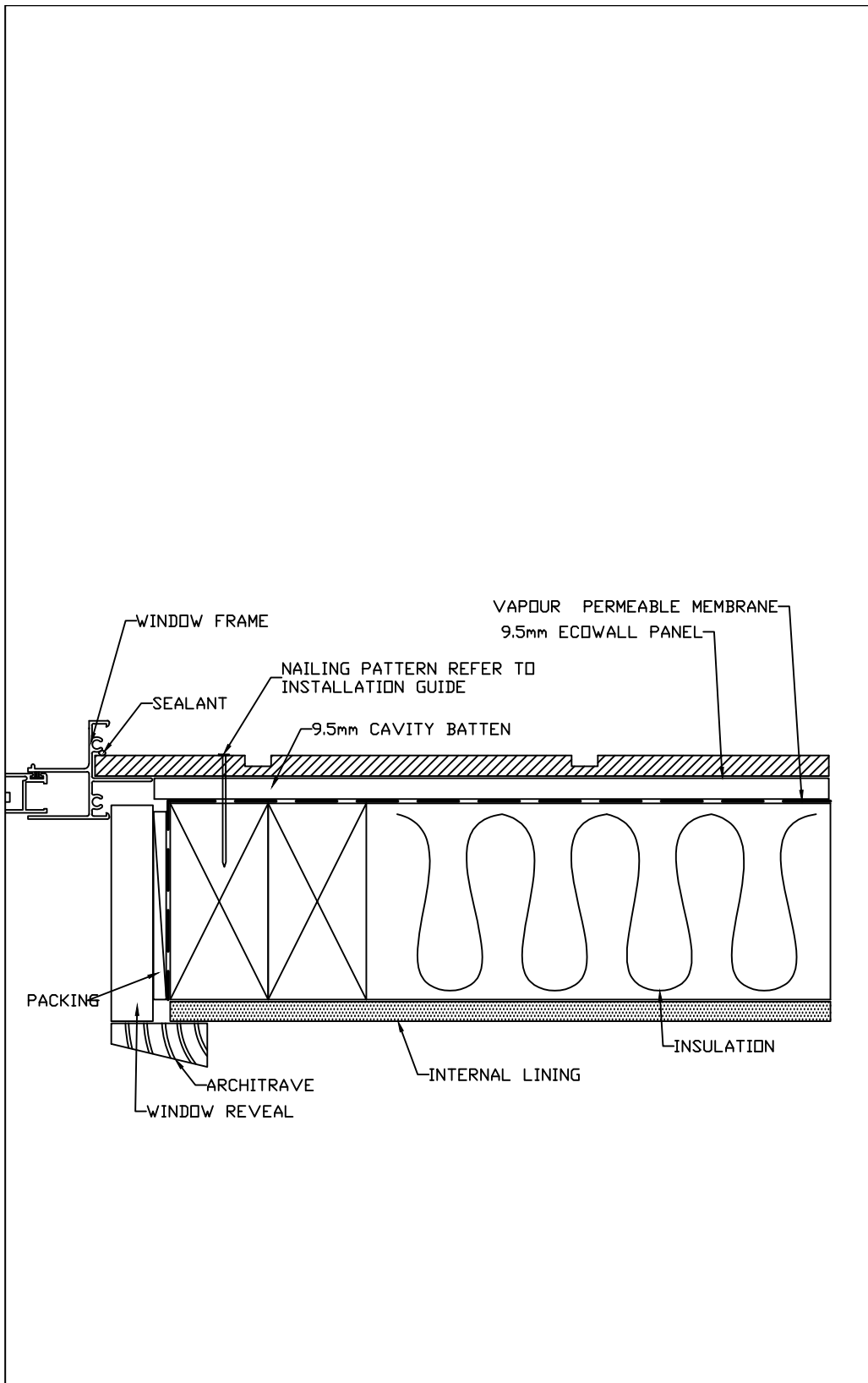

WINDOW JAMB DETAIL

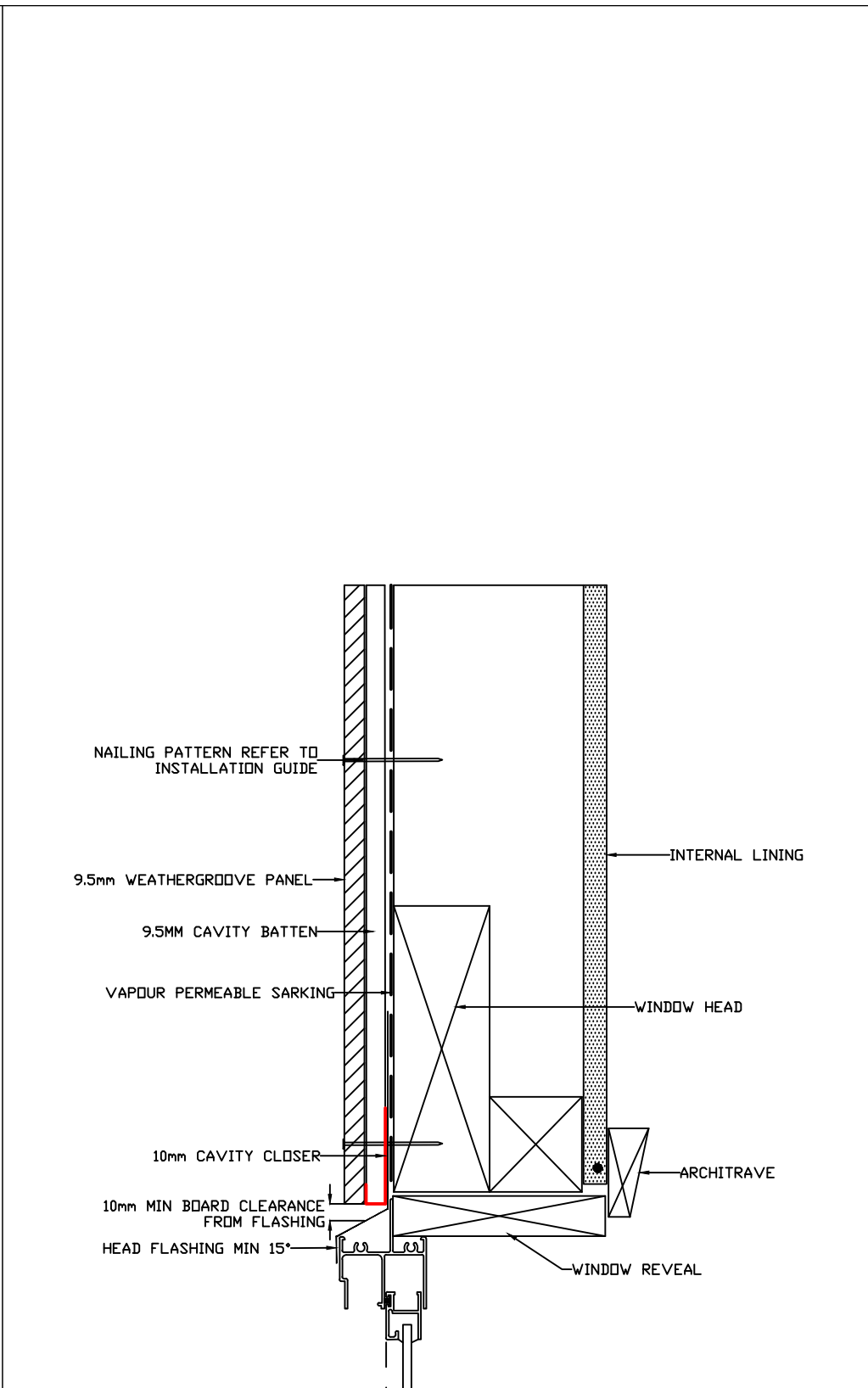

WINDOW HEAD DETAIL

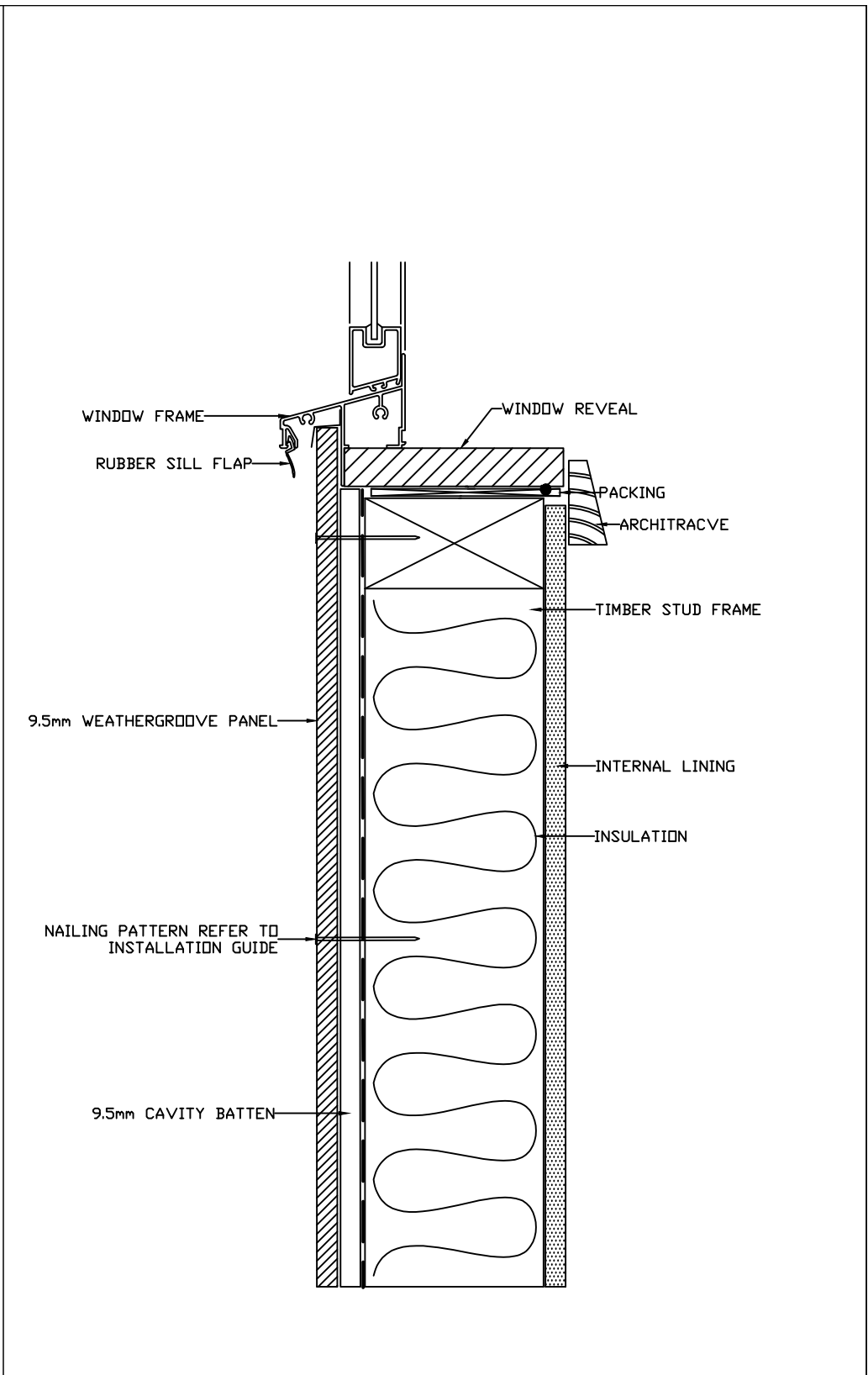

WINDOW SILL DETAIL

	DRAWING NAME:	SCALE:	DRAWN BY:	CHECKED BY:	DATE:	DRAWING SET No.:	SHT SIZE
	9.5mm CAVITY INSTALLATION - WEATHERGROOVE	NTS	A.MOATE	C.O'NEILL	26.10.17	CD-WG-C	A3

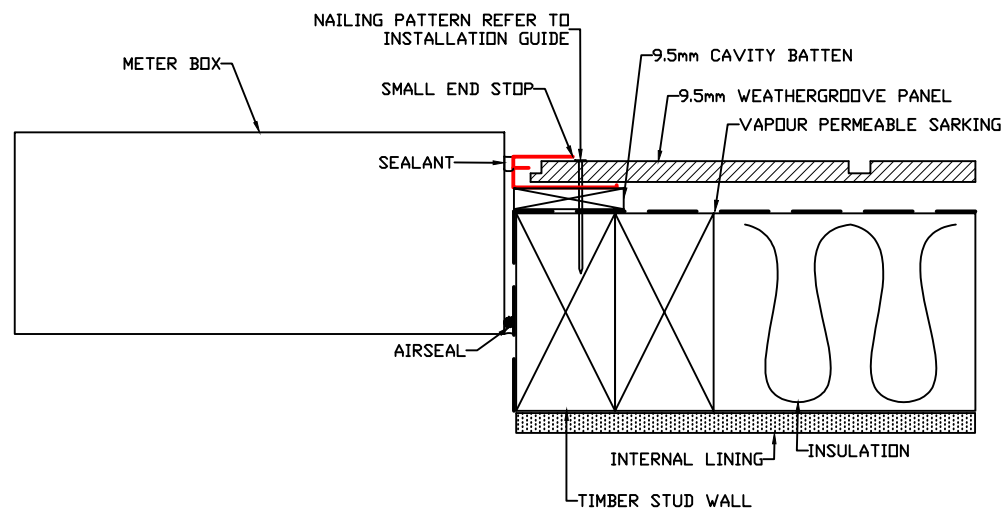

METER BOX JAMB
DETAIL

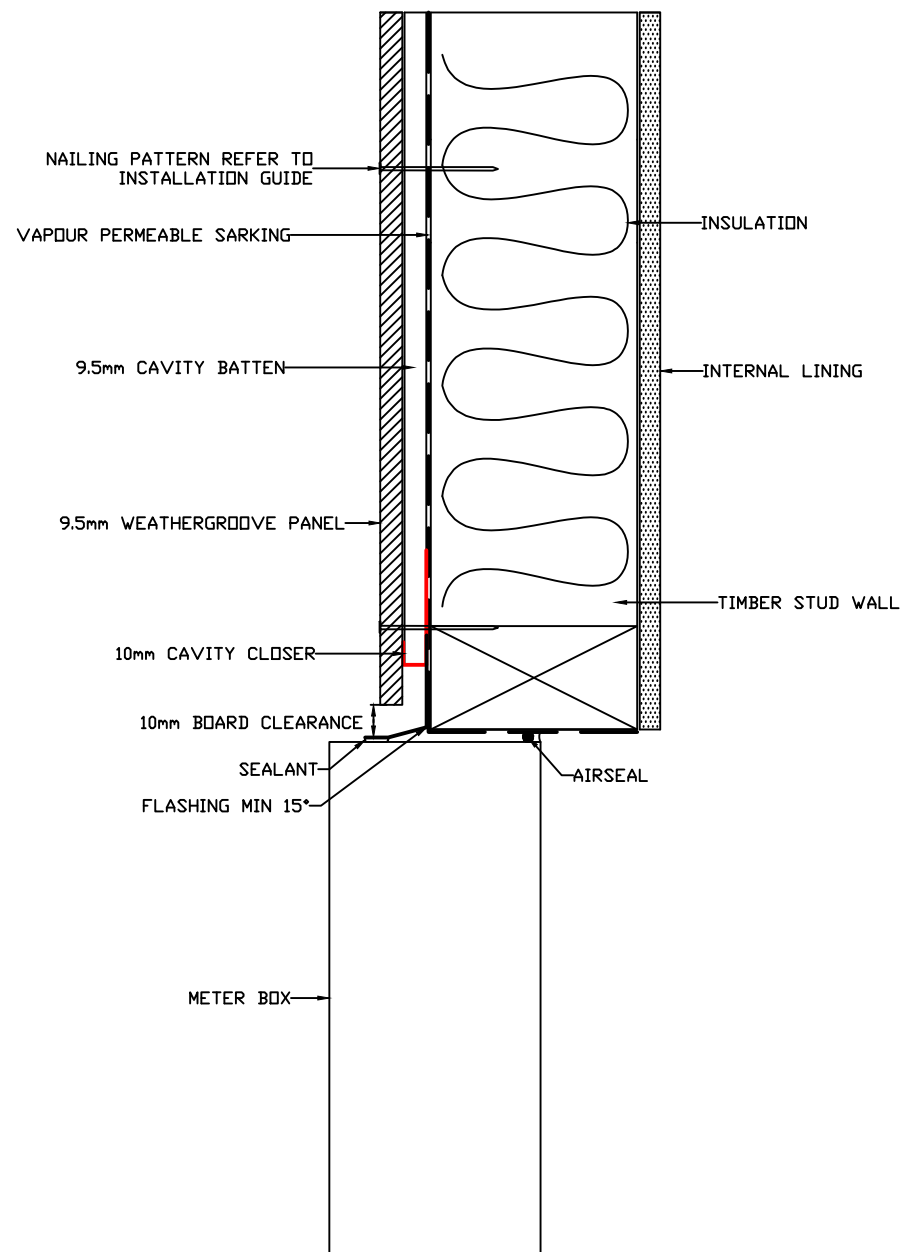

METER BOX HEAD
DETAIL

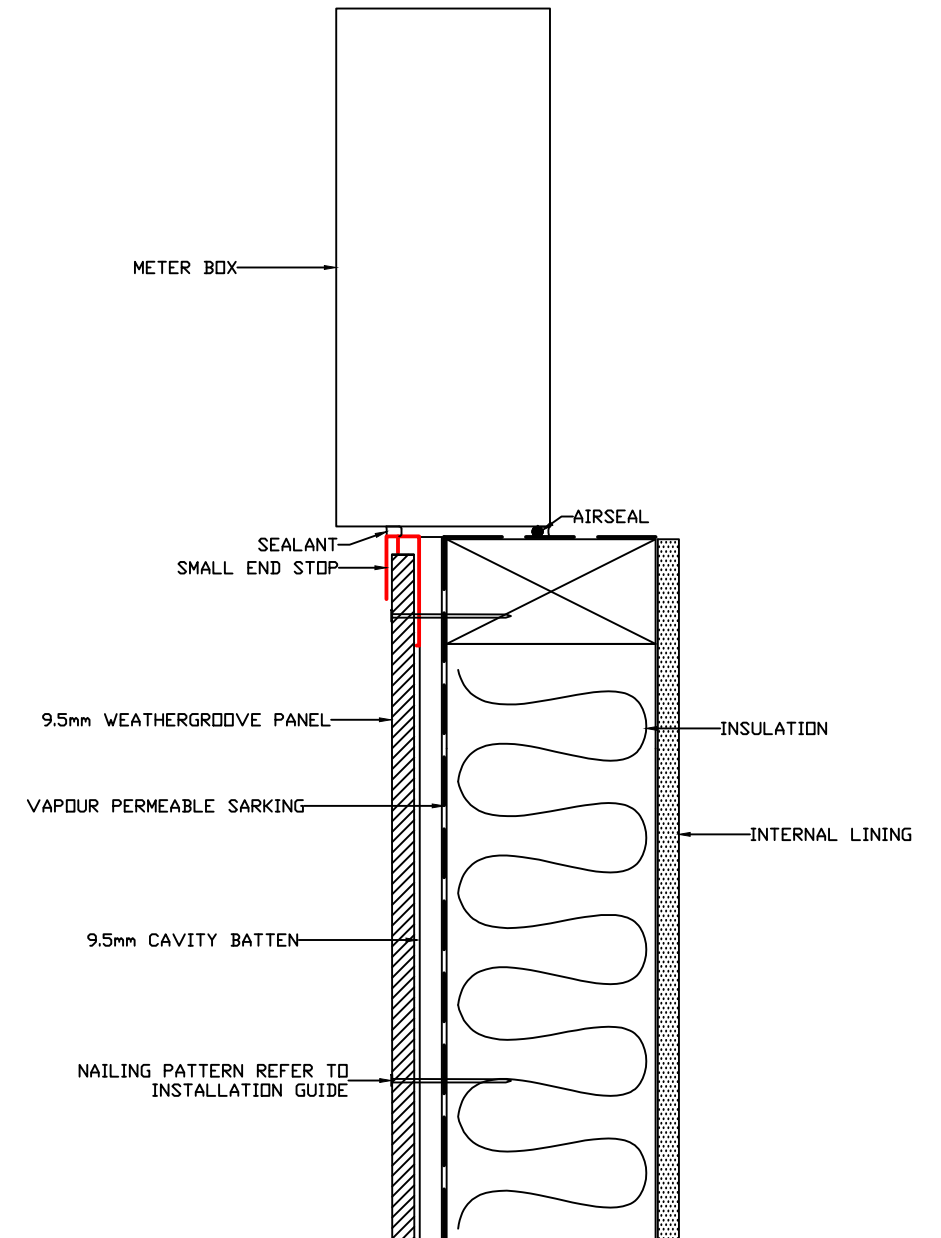

METER BOX SILL
DETAIL

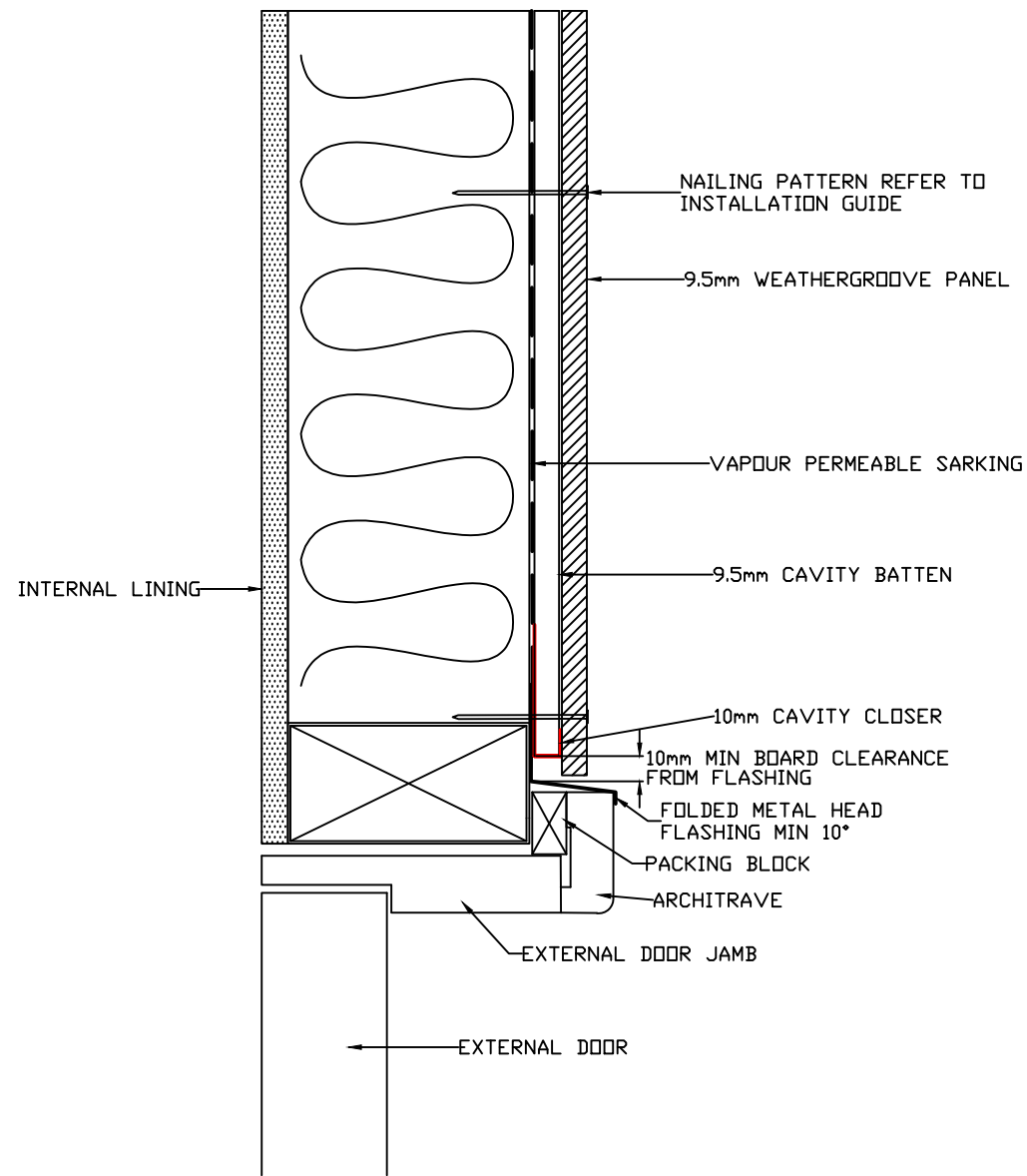

DOOR HEADER DETAIL



DRAWING NAME:
9.5mm CAVITY INSTALLATION - WEATHERGROOVE

SCALE:
NTS

DRAWN BY:
A.MOATE

CHECKED BY:
C.O'NEILL

DATE:
26.10.17

DRAWING SET No.:
CD-WG-C

SHT SIZE
A3

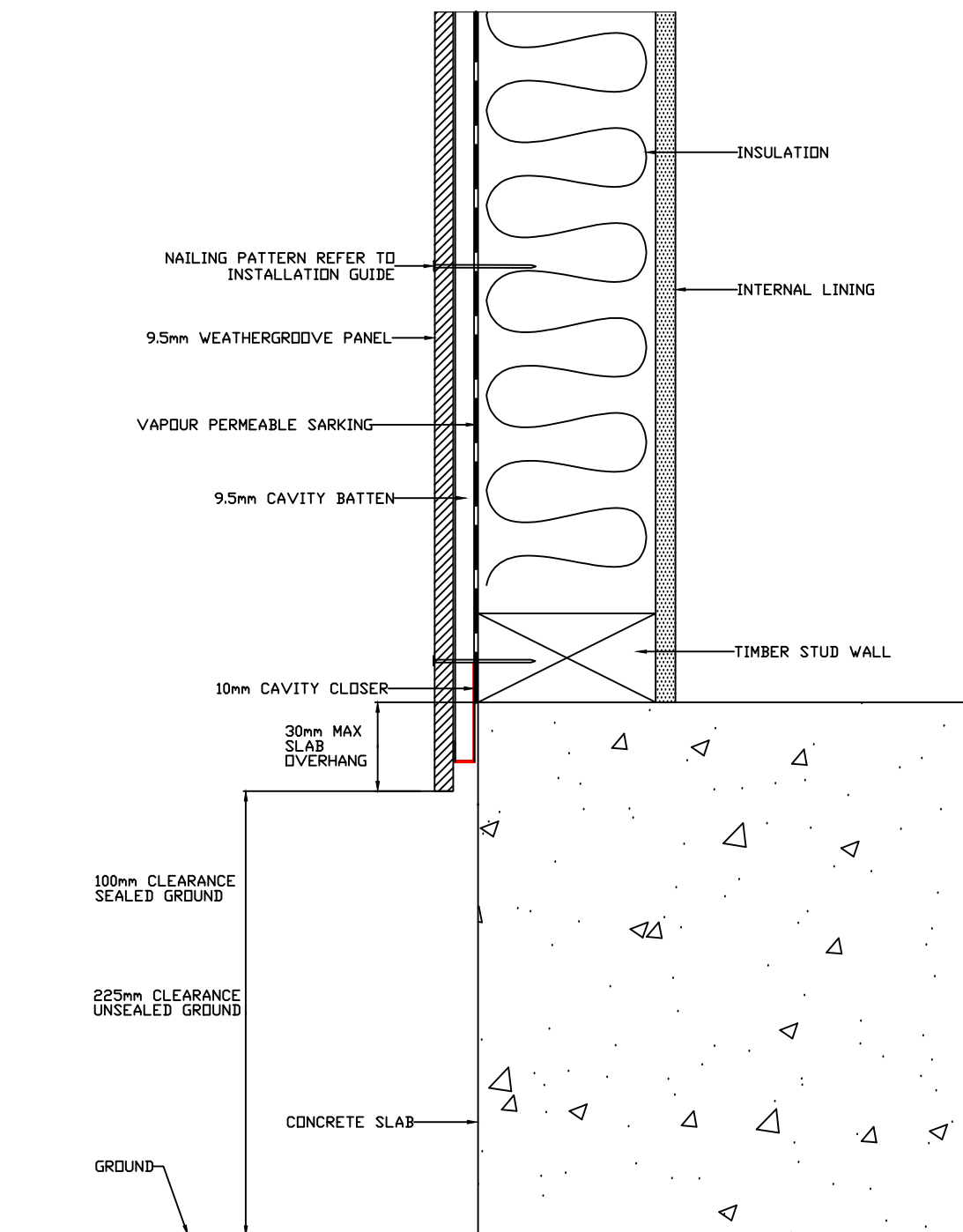

CONCRETE SLAB
GROUND CLEARANCE DETAIL

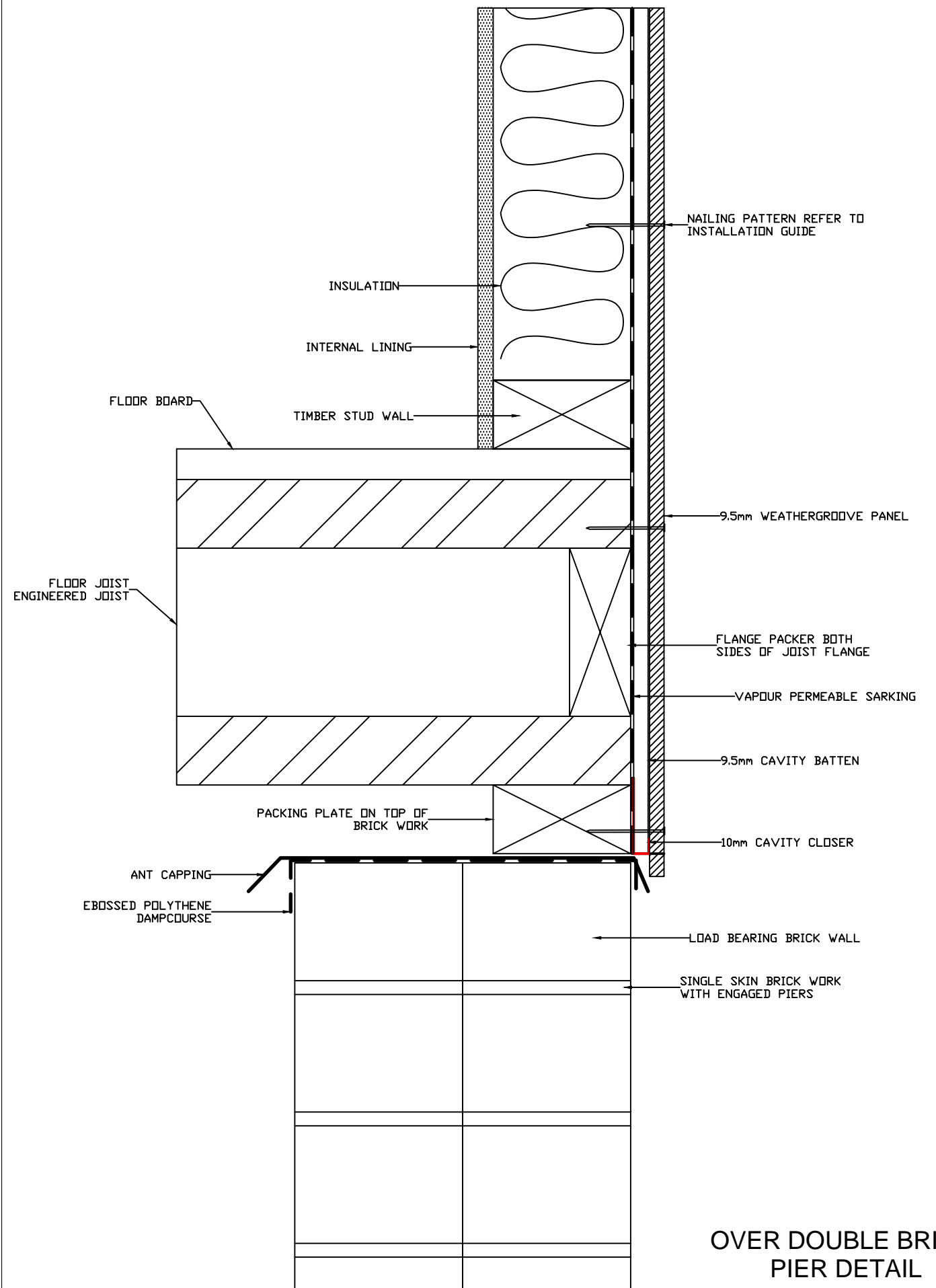

OVER DOUBLE BRICK
PIER DETAIL

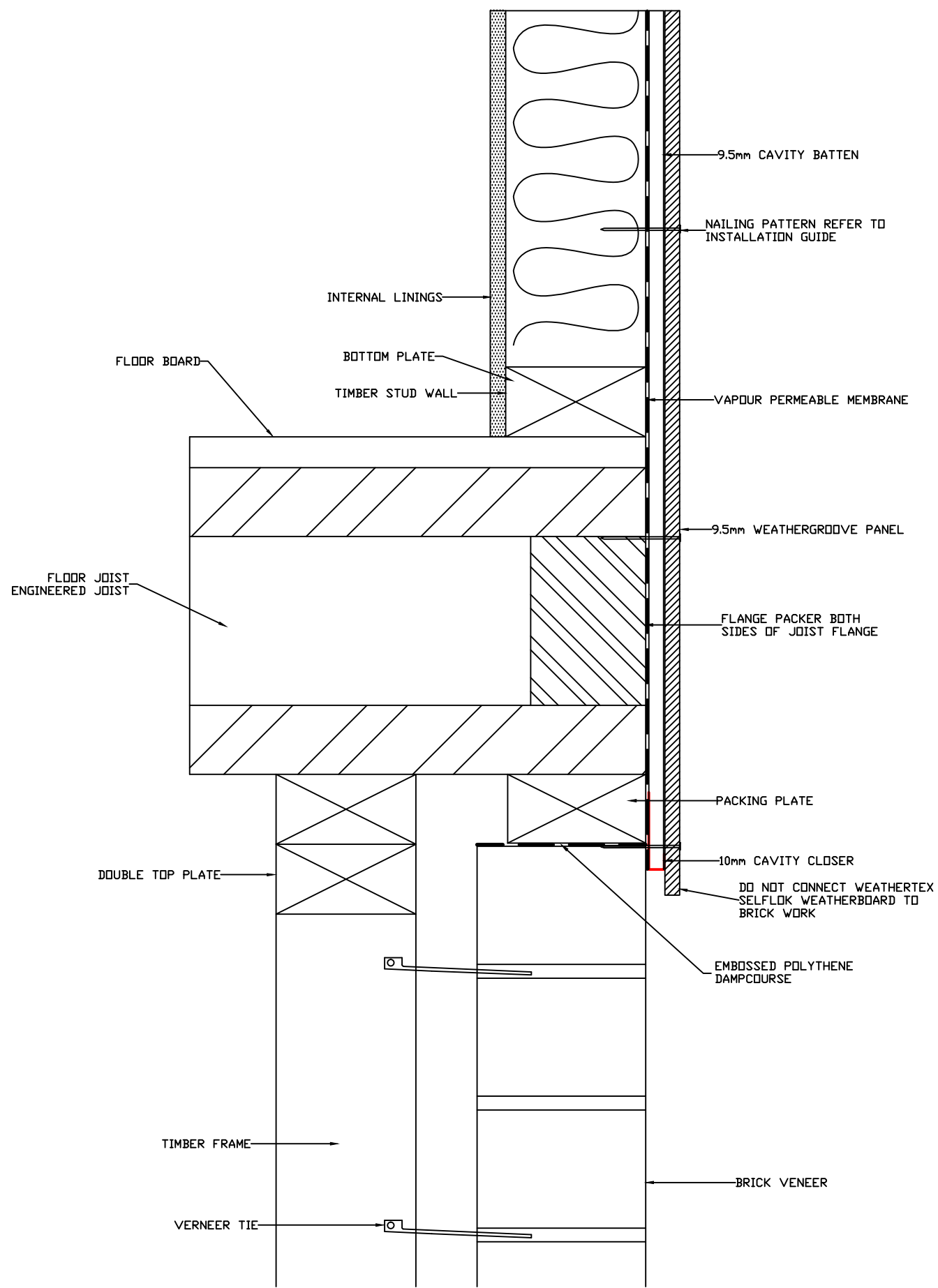

FLUSH WITH BRICK VENEER DETAIL

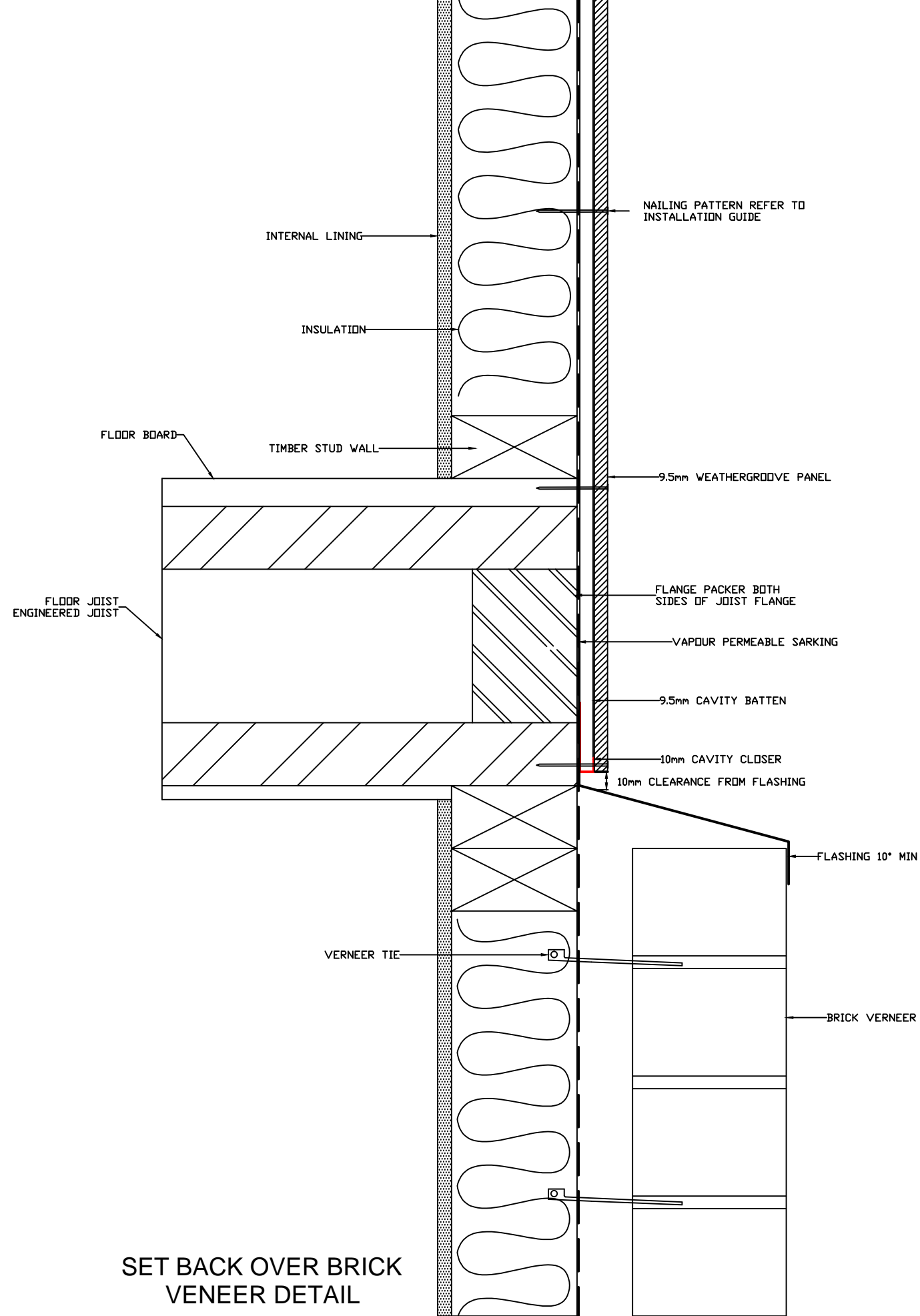

SET BACK OVER BRICK VENEER DETAIL



DRAWING NAME:
9.5mm CAVITY INSTALLATION - WEATHERGROOVE

SCALE:
NTS

DRAWN BY:
A.MOATE

CHECKED BY:
C.O'NEILL

DATE:
26.10.17

DRAWING SET No.:
CD-WG-C

SHT SIZE
A3

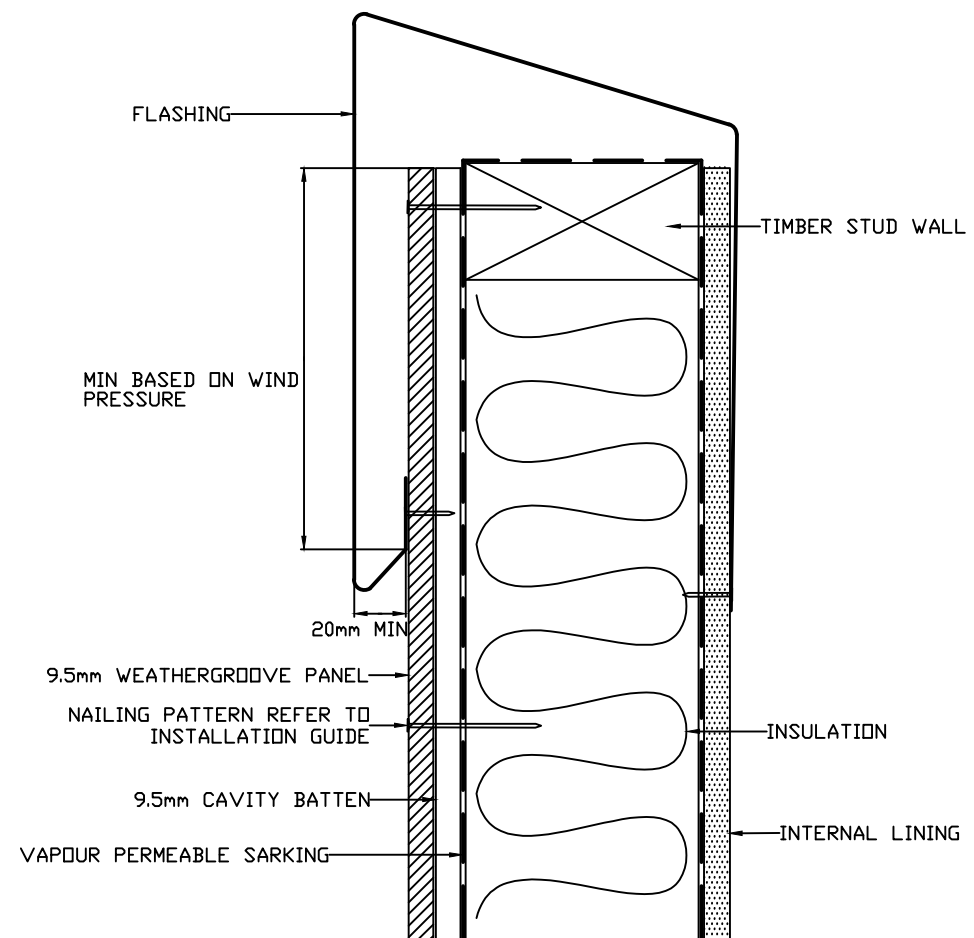

PARAPET DETAIL

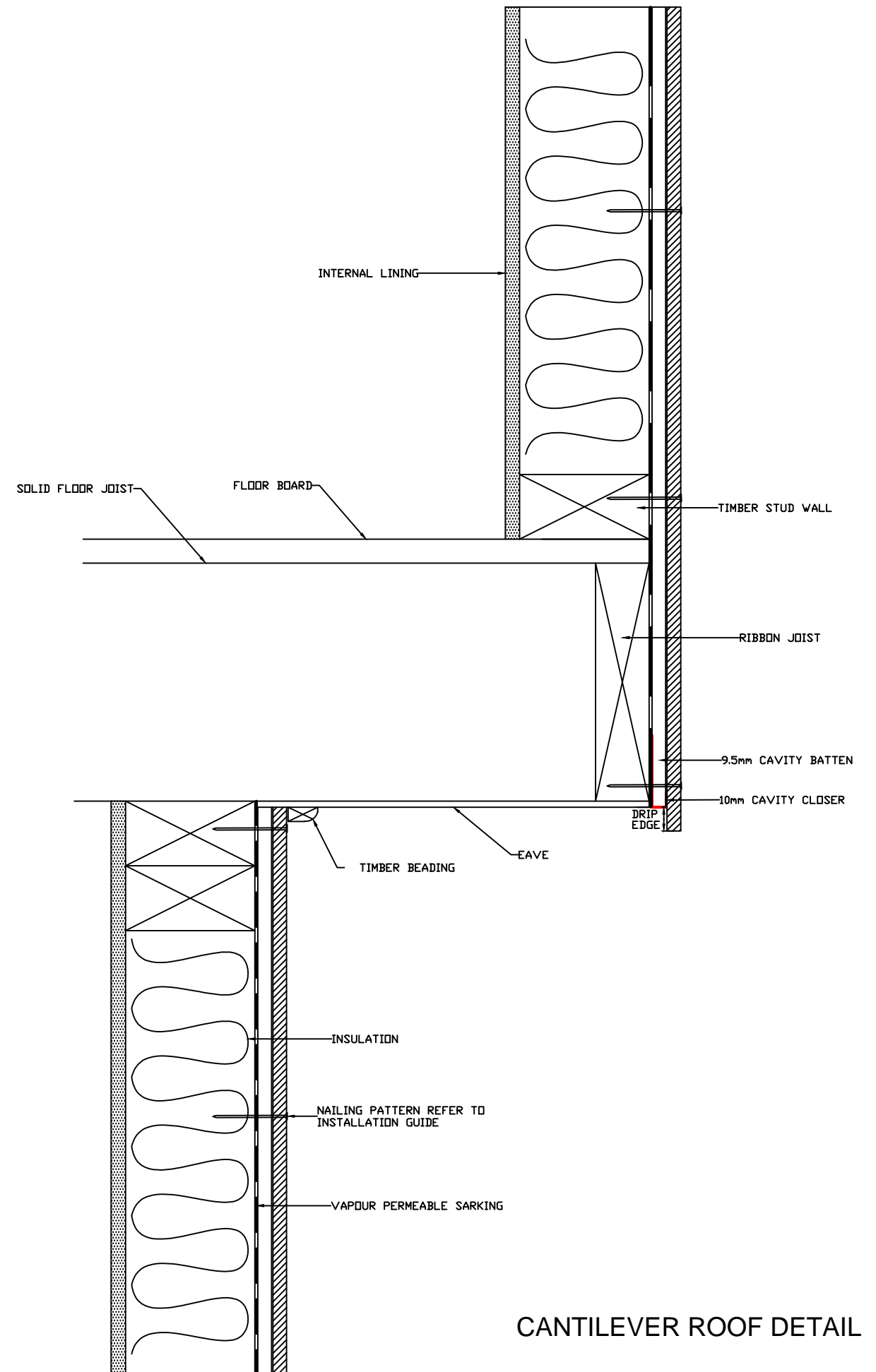

CANTILEVER ROOF DETAIL



DRAWING NAME:
9.5mm CAVITY INSTALLATION - WEATHERGROOVE

SCALE:
NTS

DRAWN BY:
A.MOATE

CHECKED BY:
C.O'NEILL

DATE:
26.10.17

DRAWING SET No.:
CD-WG-C

SHT SIZE
A3

ROOF CLEARANCE DETAIL

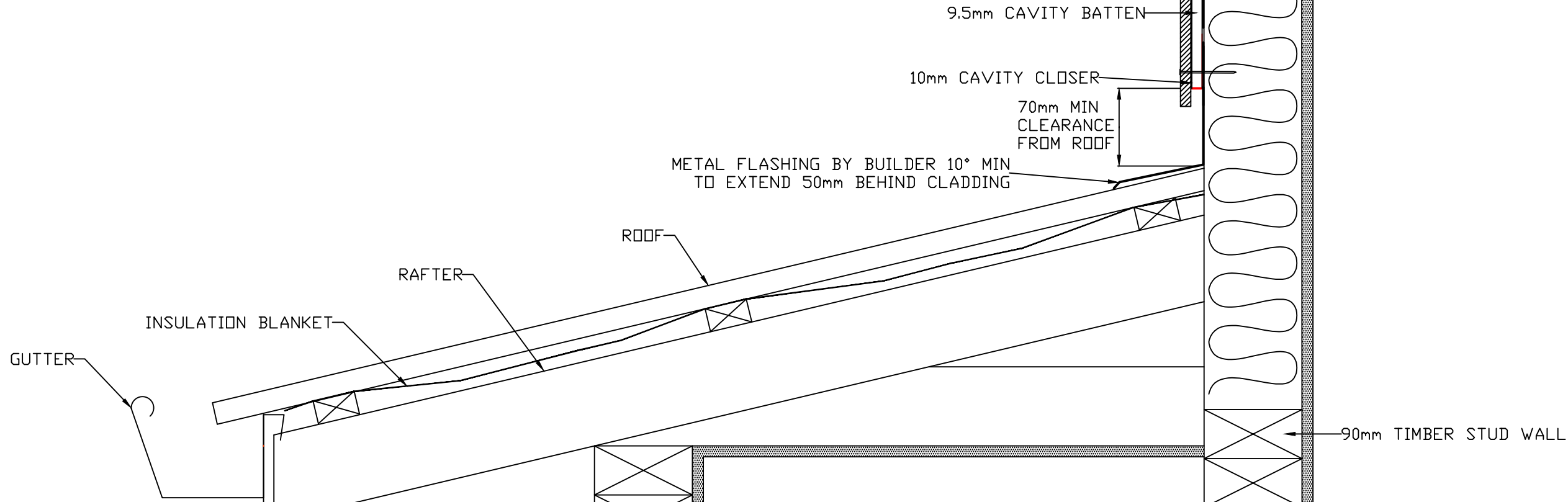

EAVE DETAIL

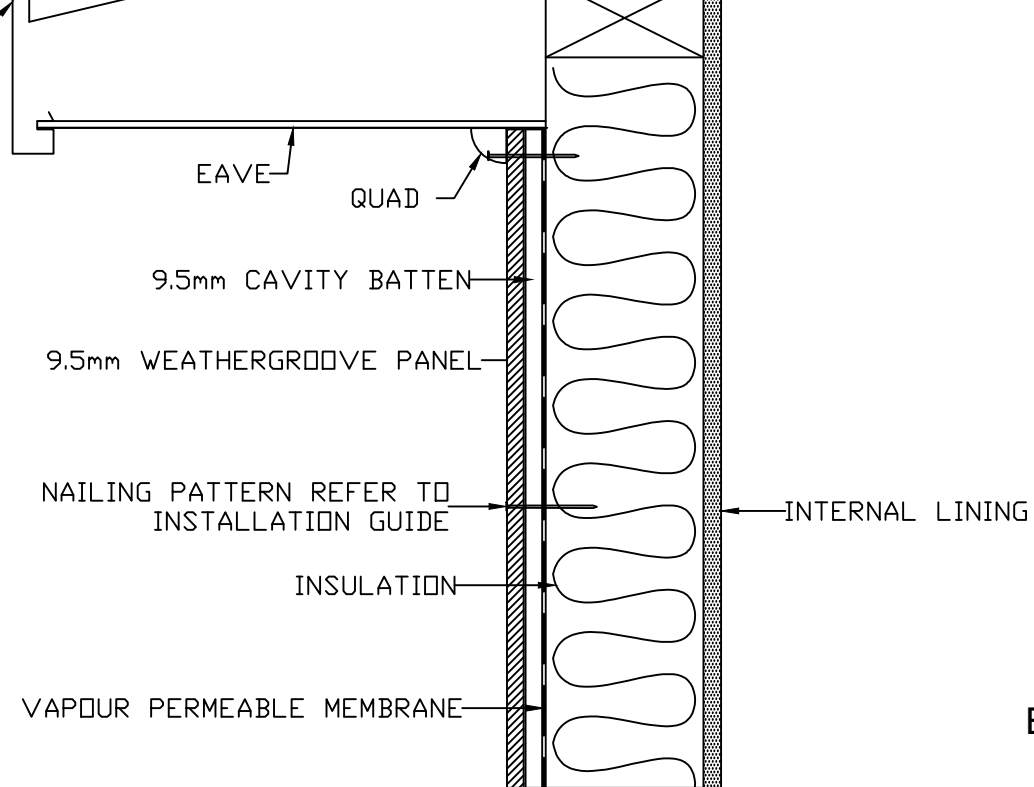

EAVE AND ROOF CLEARANCE DETAIL



DRAWING NAME:	SCALE:	DRAWN BY:	CHECKED BY:	DATE:	DRAWING SET No.:	SHT SIZE
9.5mm CAVITY INSTALLATION - WEATHERGROOVE	NTS	A.MOATE	C.O'NEILL	26.10.17	CD-WG-C	A3

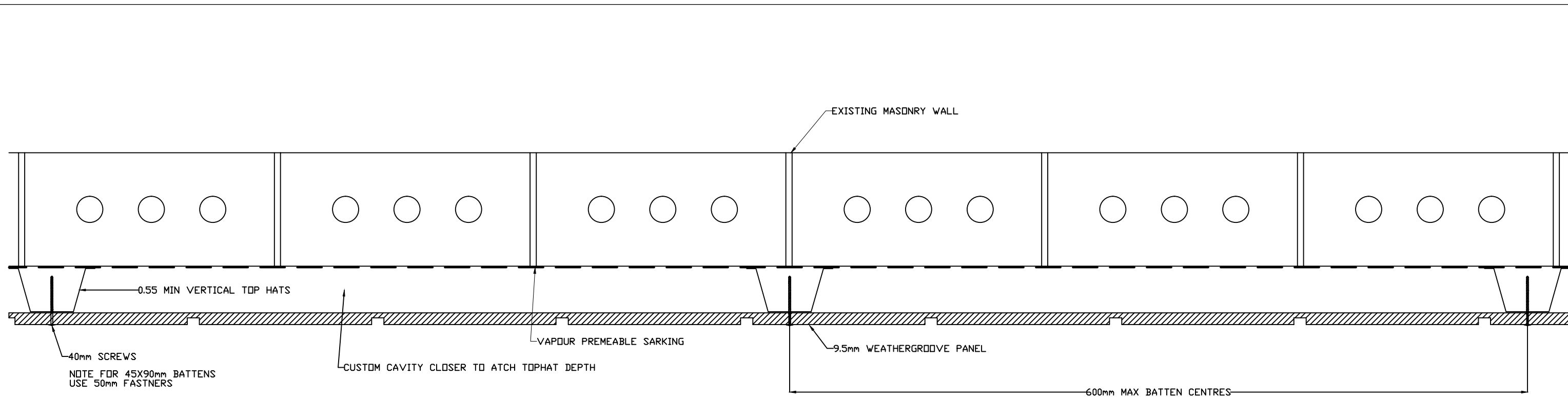

**CLADDING OVER MASONRY WITH
METAL TOPHATS DETAIL**

NOTE: VERTICAL BATTENS ONLY

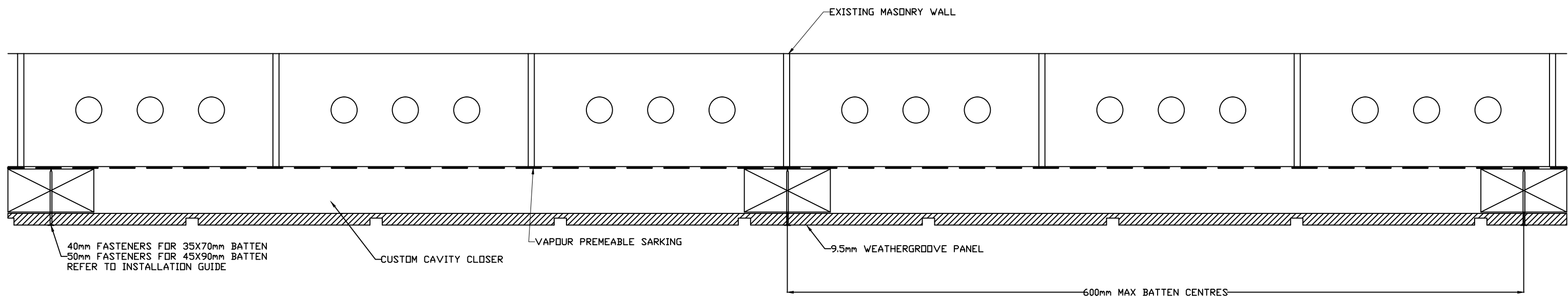

**CLADDING OVER BRICK WITH
TIMBER BATTEN DETAIL**

NOTE: VERTICAL BATTENS ONLY