

# WEATHERTEX CONSTRUCTION DETAIL GUIDE

## RUBIX PANELS

### 9.5mm CAVITY CONSTRUCTION

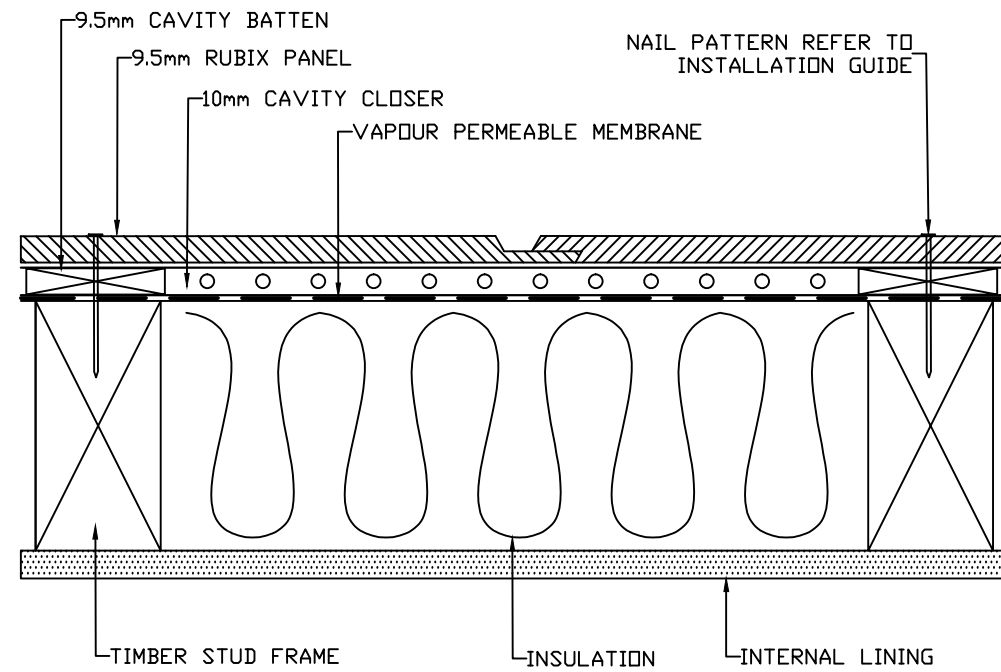



RUBIX JOIN DETAIL

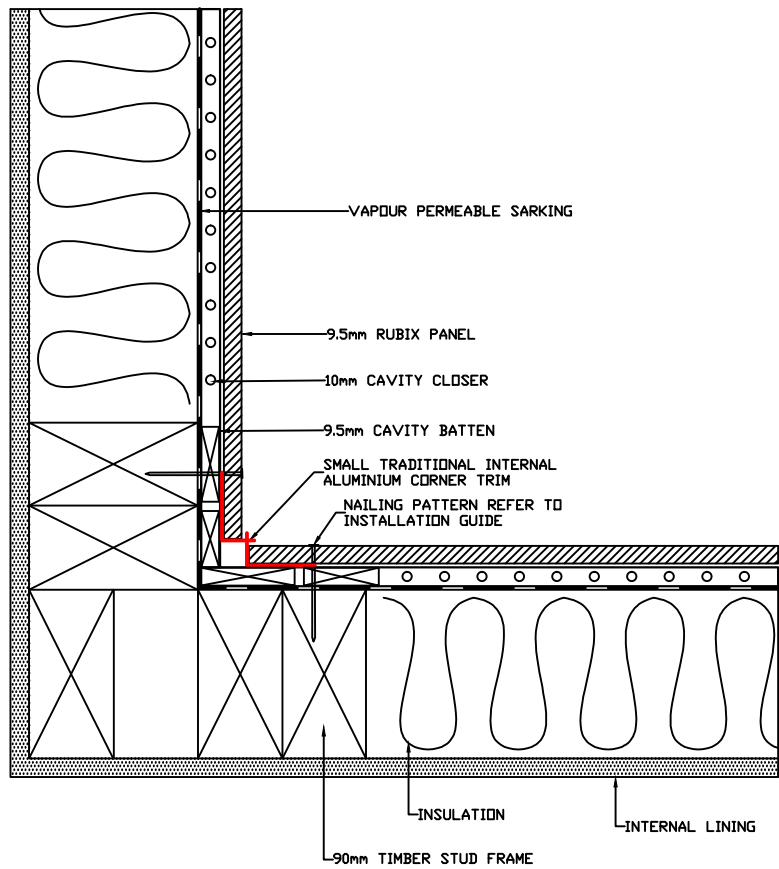

SMALL TRADITIONAL INTERNAL "W" CORNER DETAIL

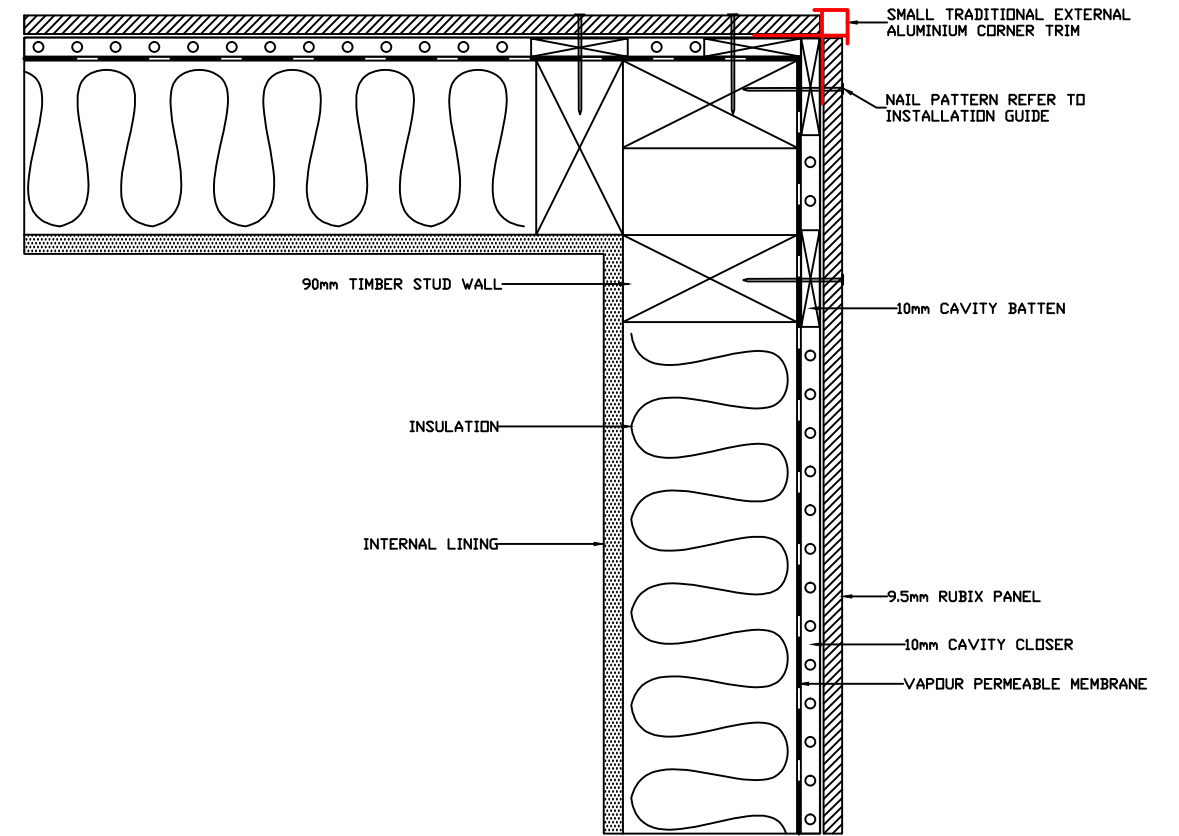

SMALL TRADITIONAL EXTERNAL "BOX" CORNER DETAIL

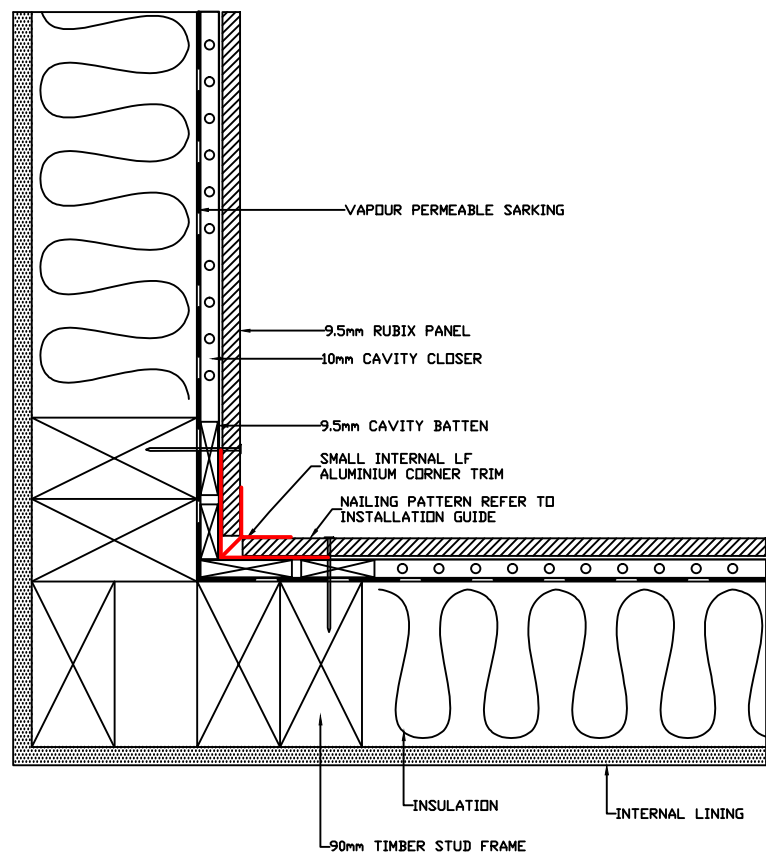

SMALL INTERNAL LF CORNER DETAIL

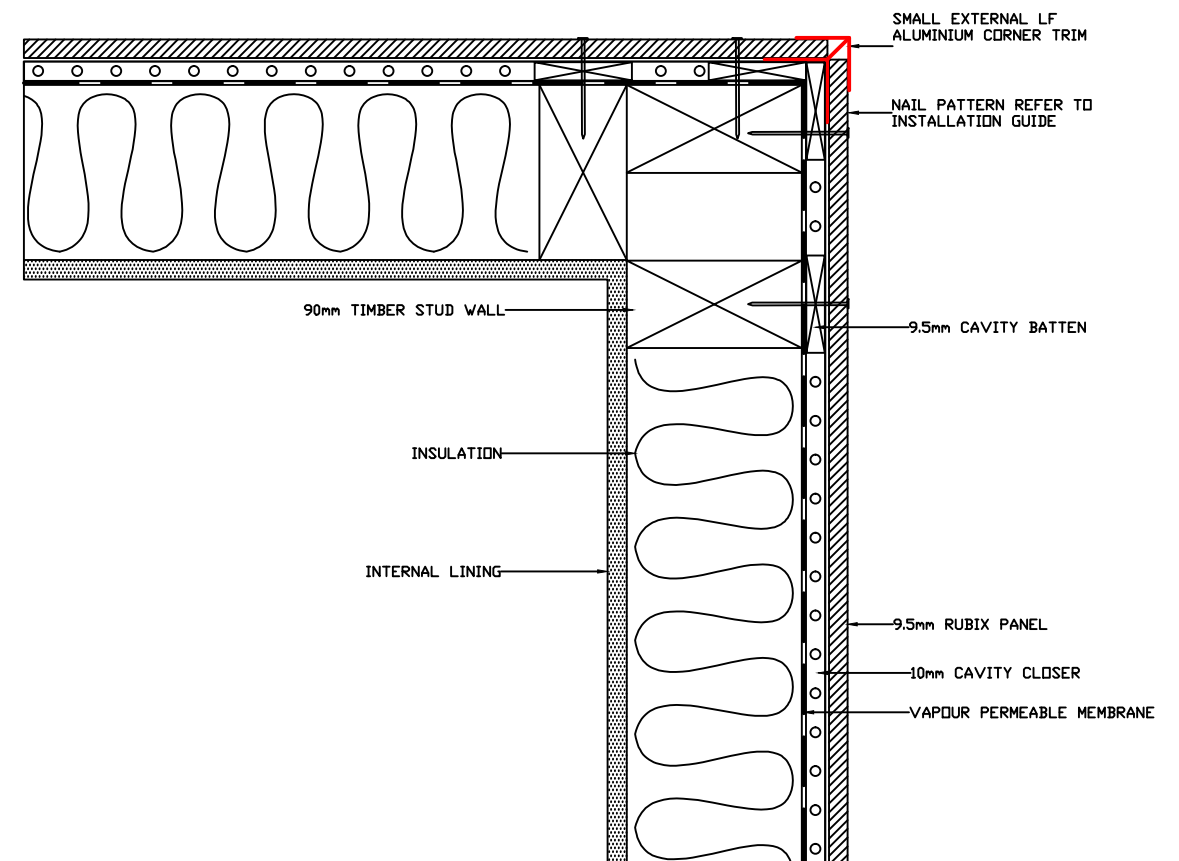

SMALL EXTERNAL LF CORNER DETAIL



DRAWING NAME:  
9.5mm CAVITY INSTALLATION - ECOWALL

SCALE:  
NTS

DRAWN BY:  
A.MOATE

CHECKED BY:  
C.O'NEILL

DATE:  
26.10.17

DRAWING SET No.:  
CD-EW-C

SHT SIZE  
A3

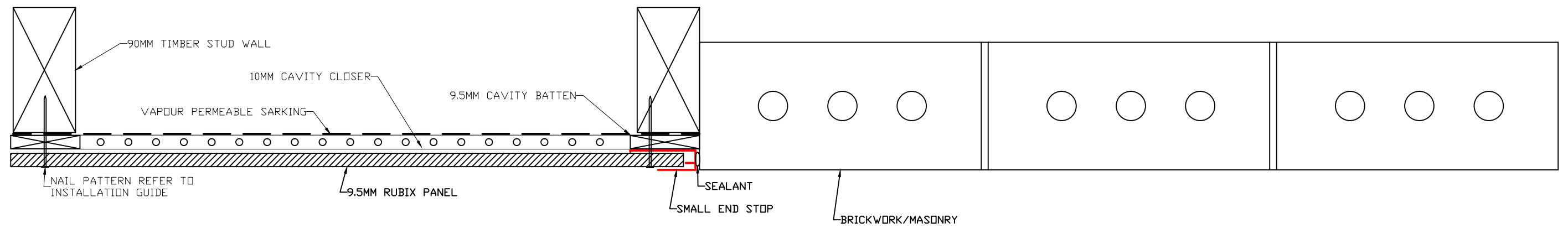

END STOP TO MASONRY BRICK DETAIL



DRAWING NAME:	SCALE:	DRAWN BY:	CHECKED BY:	DATE:	DRAWING SET No.:	SHT SIZE
9.5mm CAVITY INSTALLATION - ECOWALL	NTS	A.MOATE	C.O'NEILL	26.10.17	CD-EW-C	A3

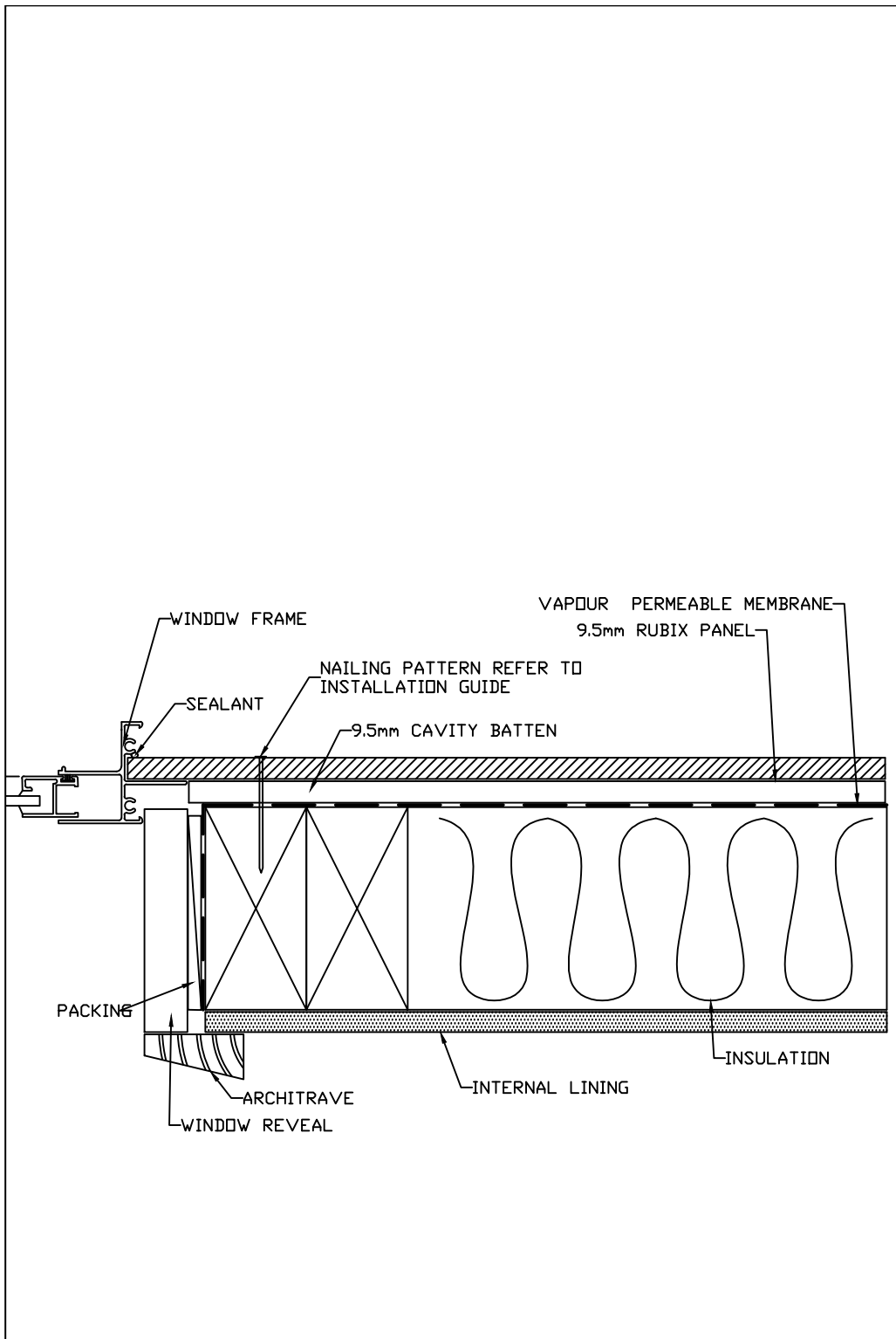

WINDOW JAMB DETAIL

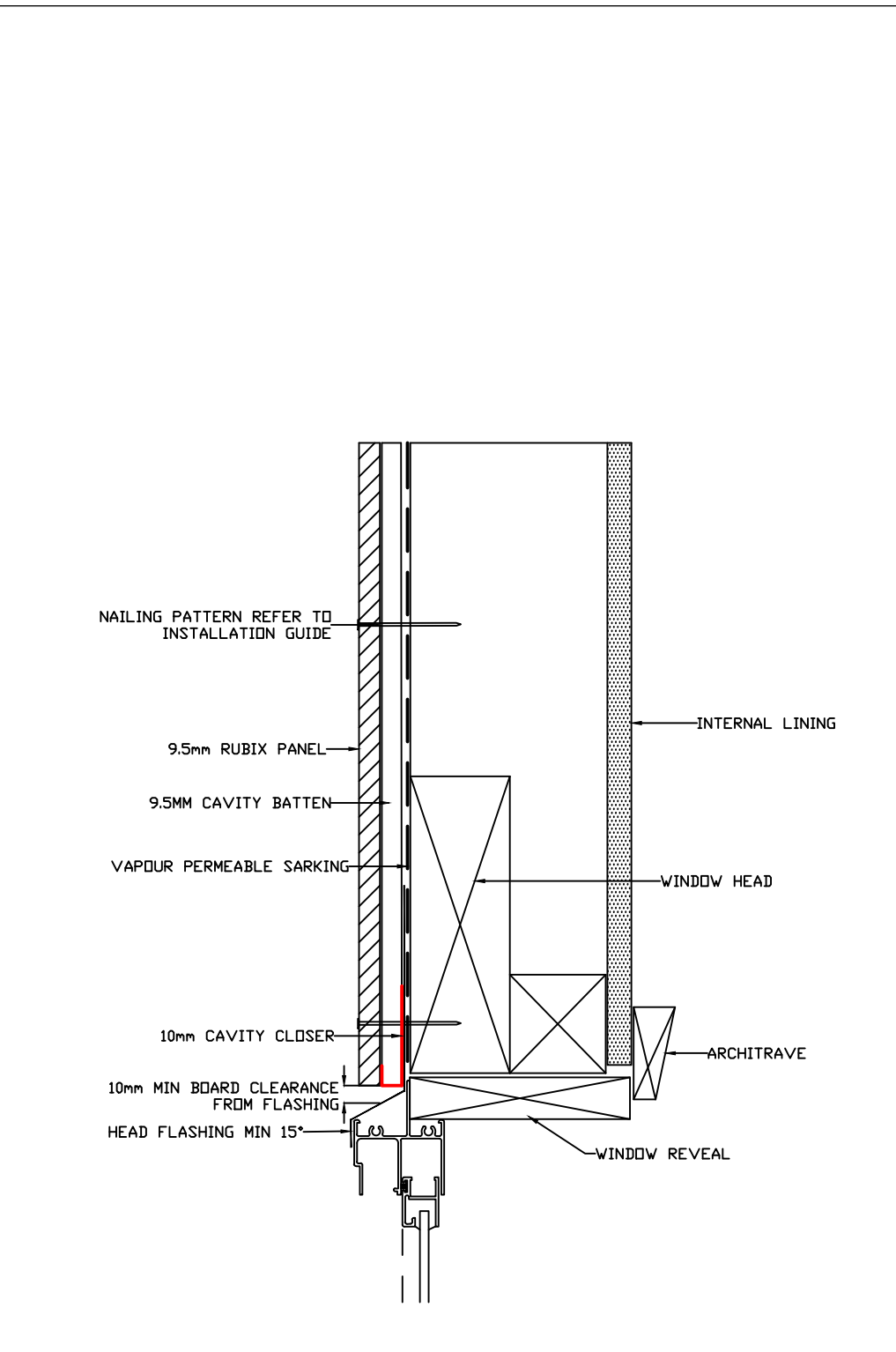

WINDOW HEAD DETAIL

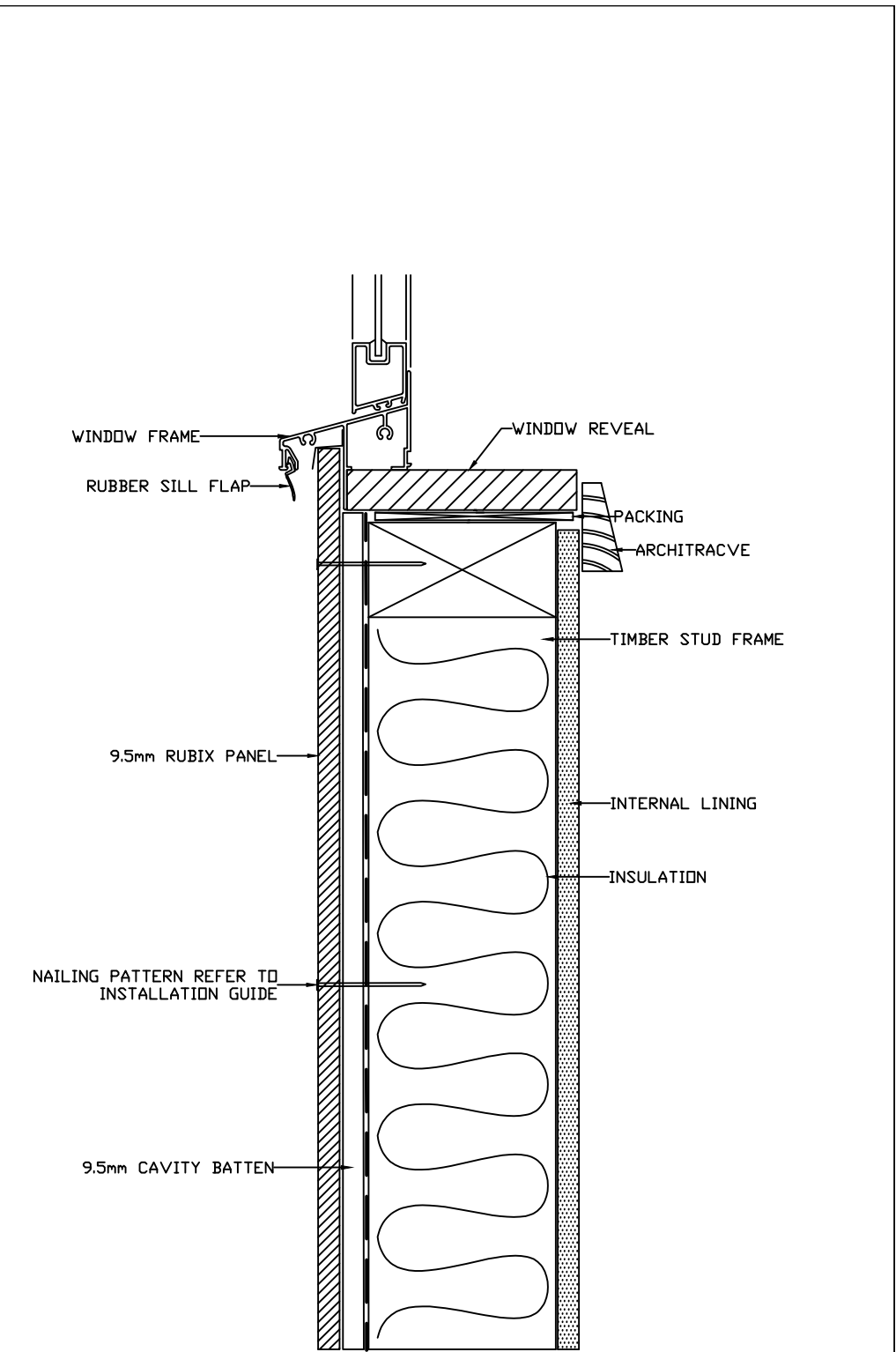

WINDOW SILL DETAIL

	DRAWING NAME:	SCALE:	DRAWN BY:	CHECKED BY:	DATE:	DRAWING SET No.:	SHT SIZE
	9.5mm CAVITY INSTALLATION - ECOWALL	NTS	A.MOATE	C.O'NEILL	26.10.17	CD-EW-C	A3

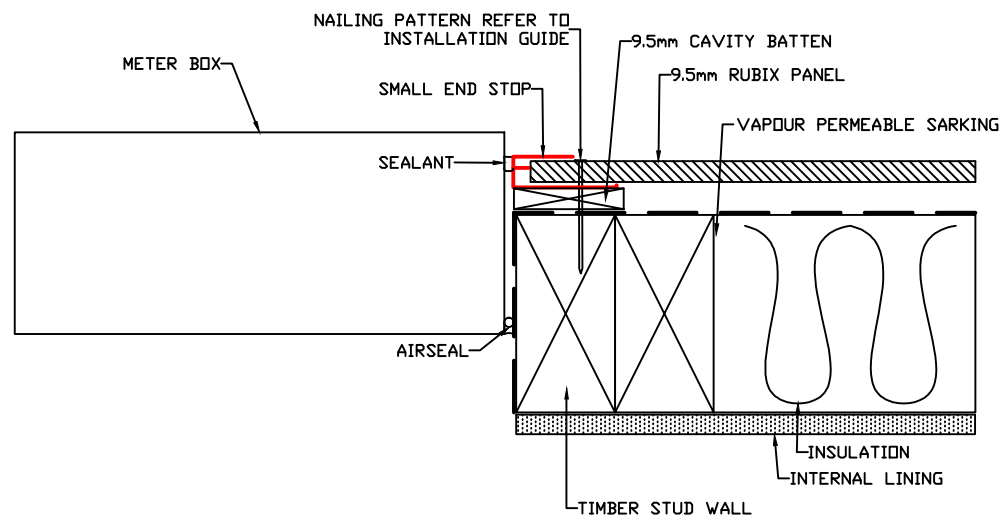

METER BOX JAMB  
DETAIL

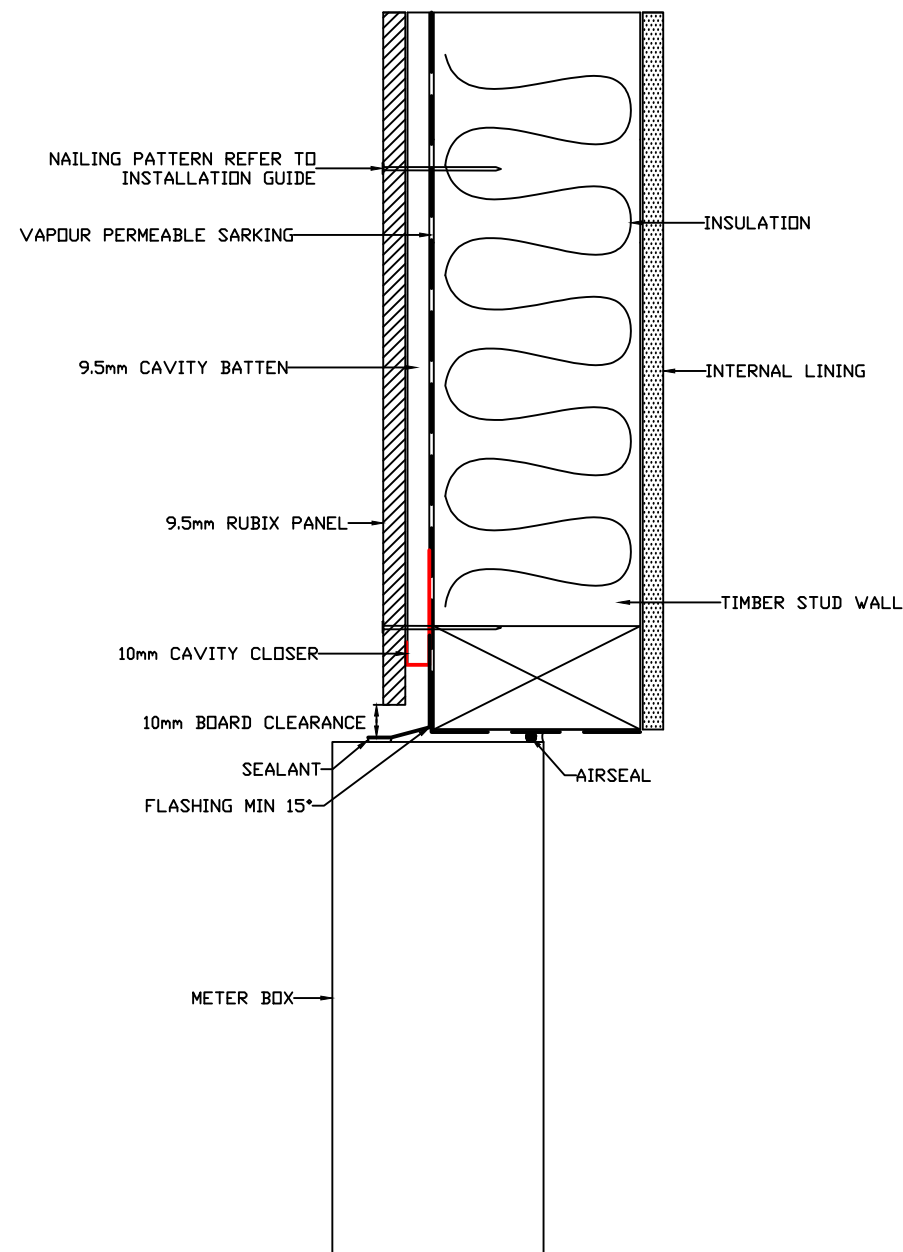

METER BOX HEAD DETAIL

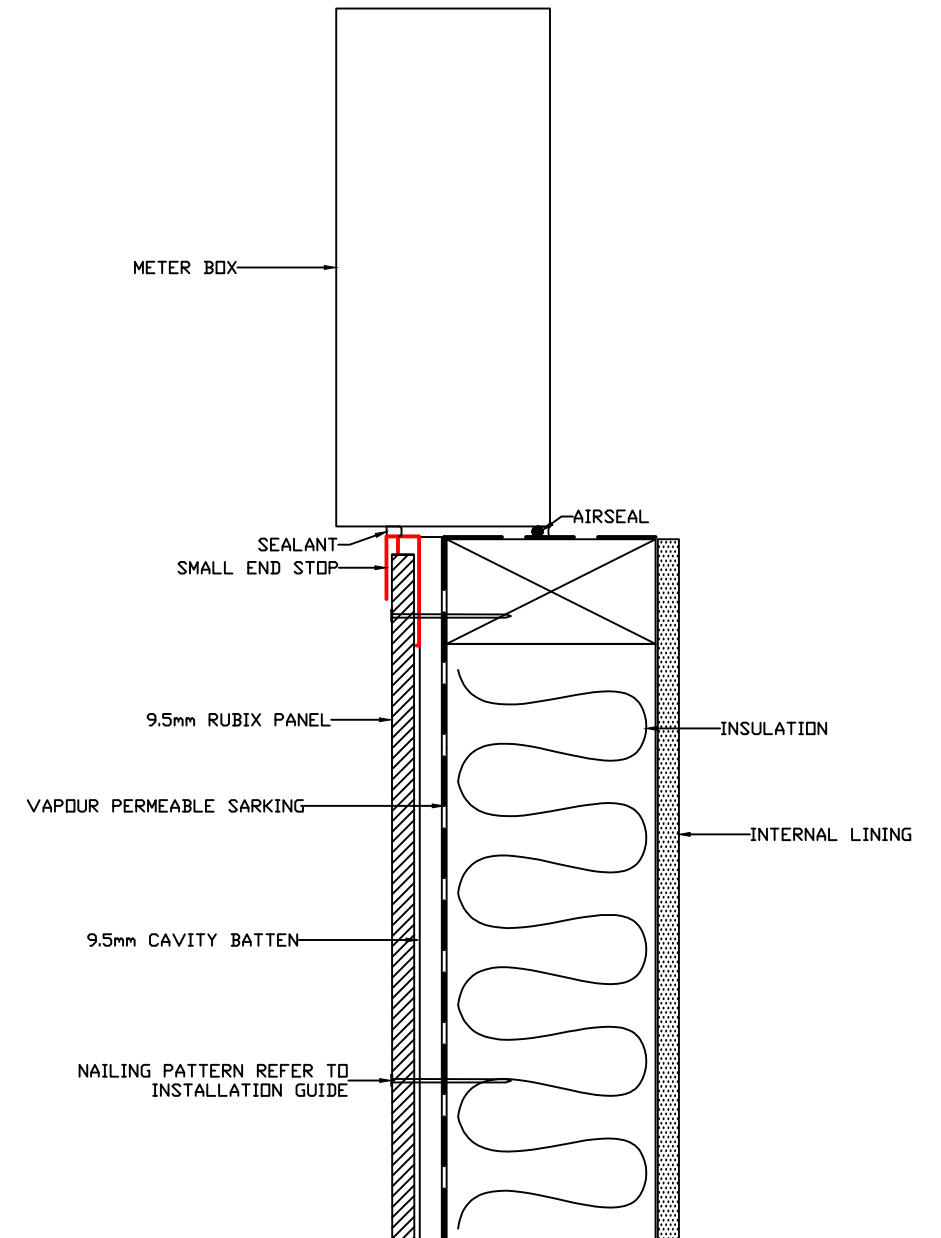

METER BOX SILL DETAIL

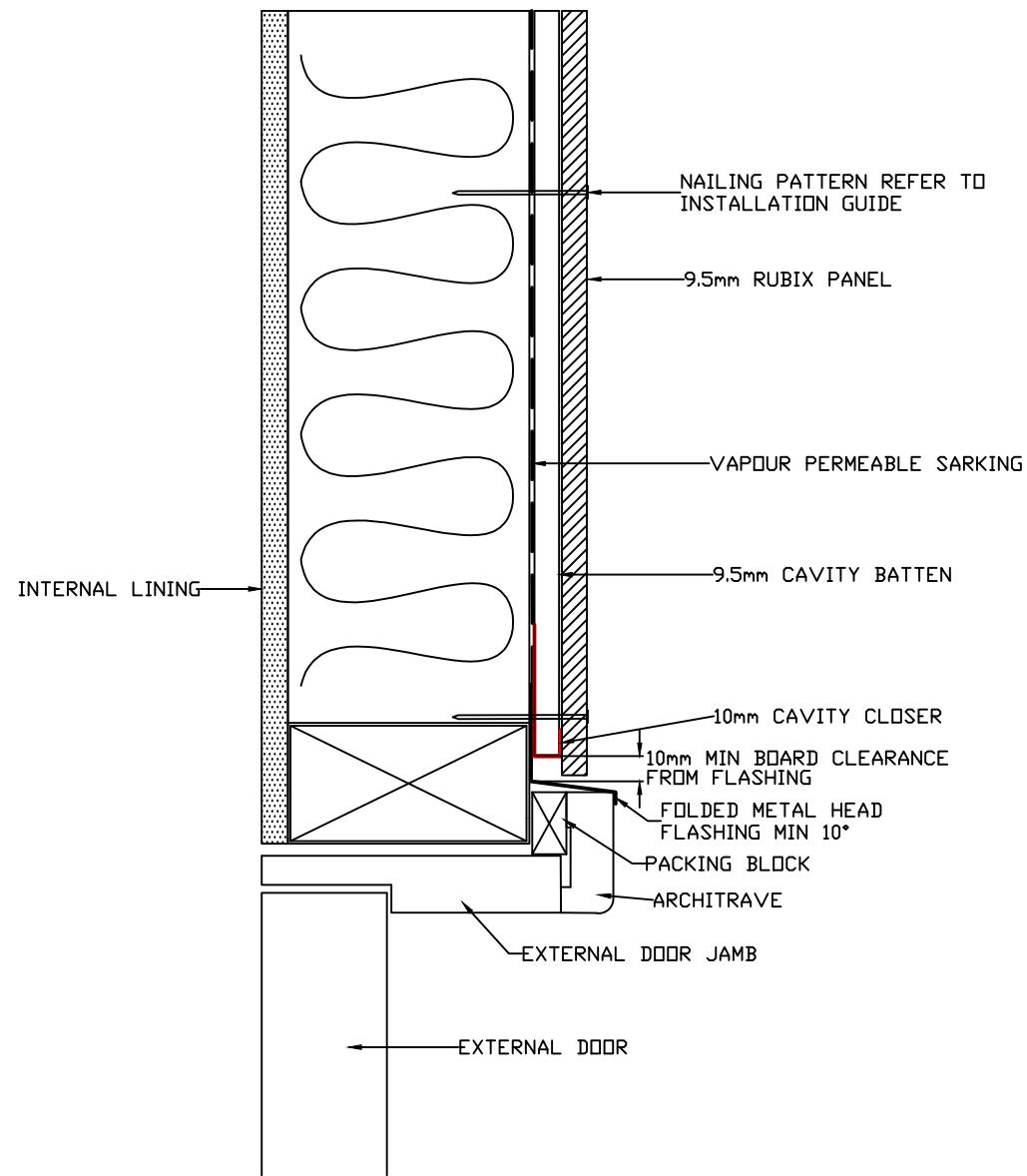

DOOR HEADER DETAIL

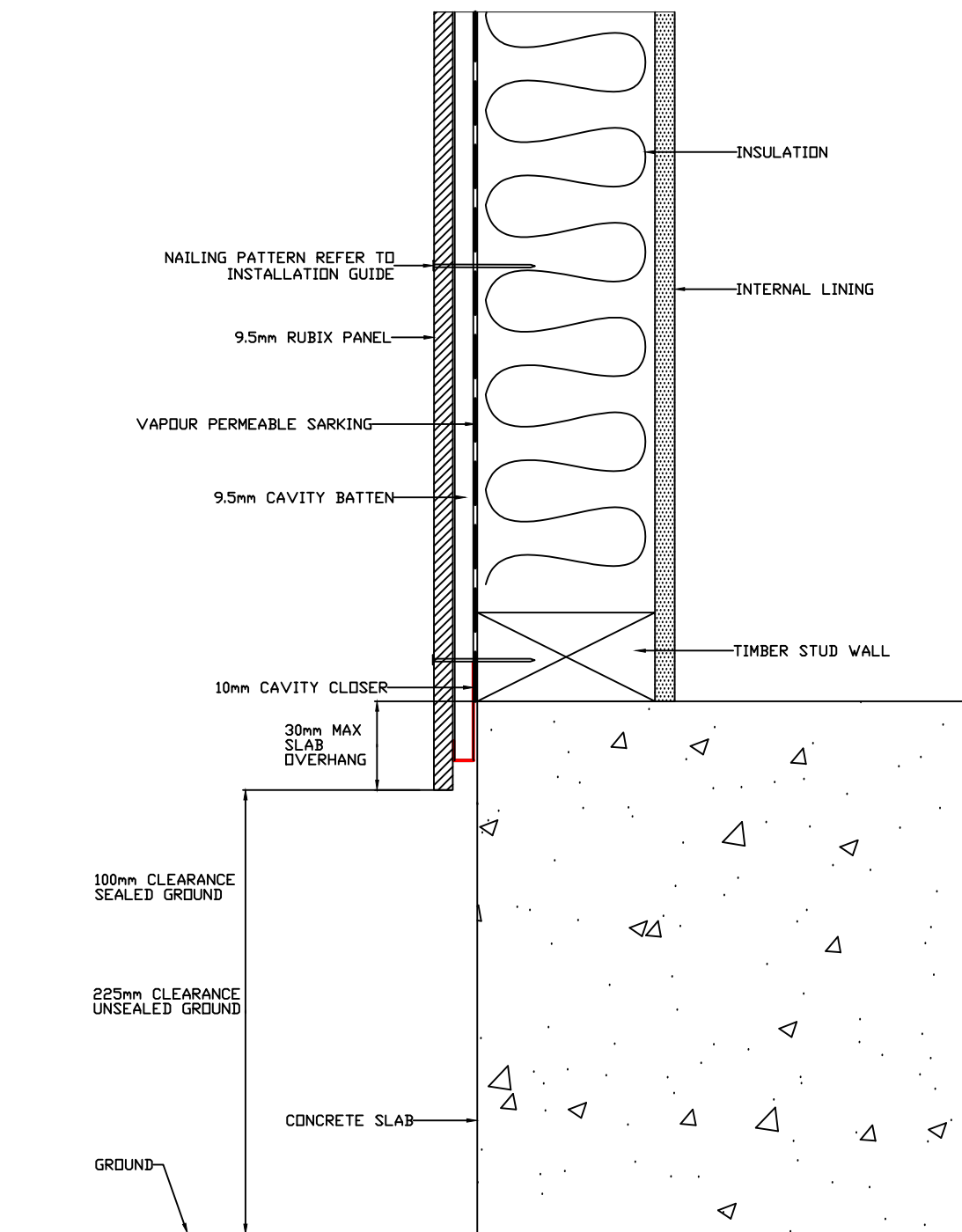

CONCRETE SLAB  
GROUND CLEARANCE DETAIL

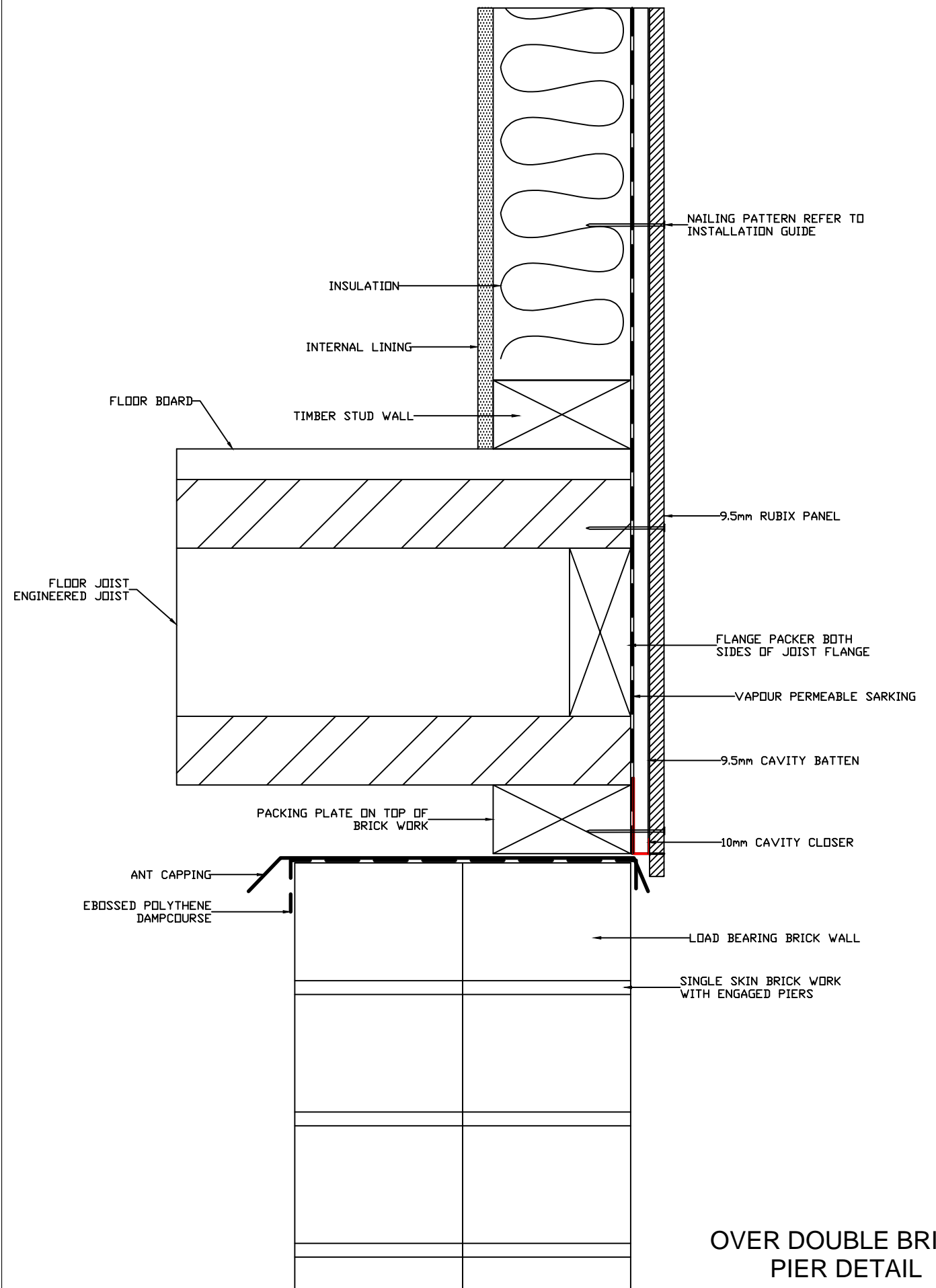

OVER DOUBLE BRICK  
PIER DETAIL



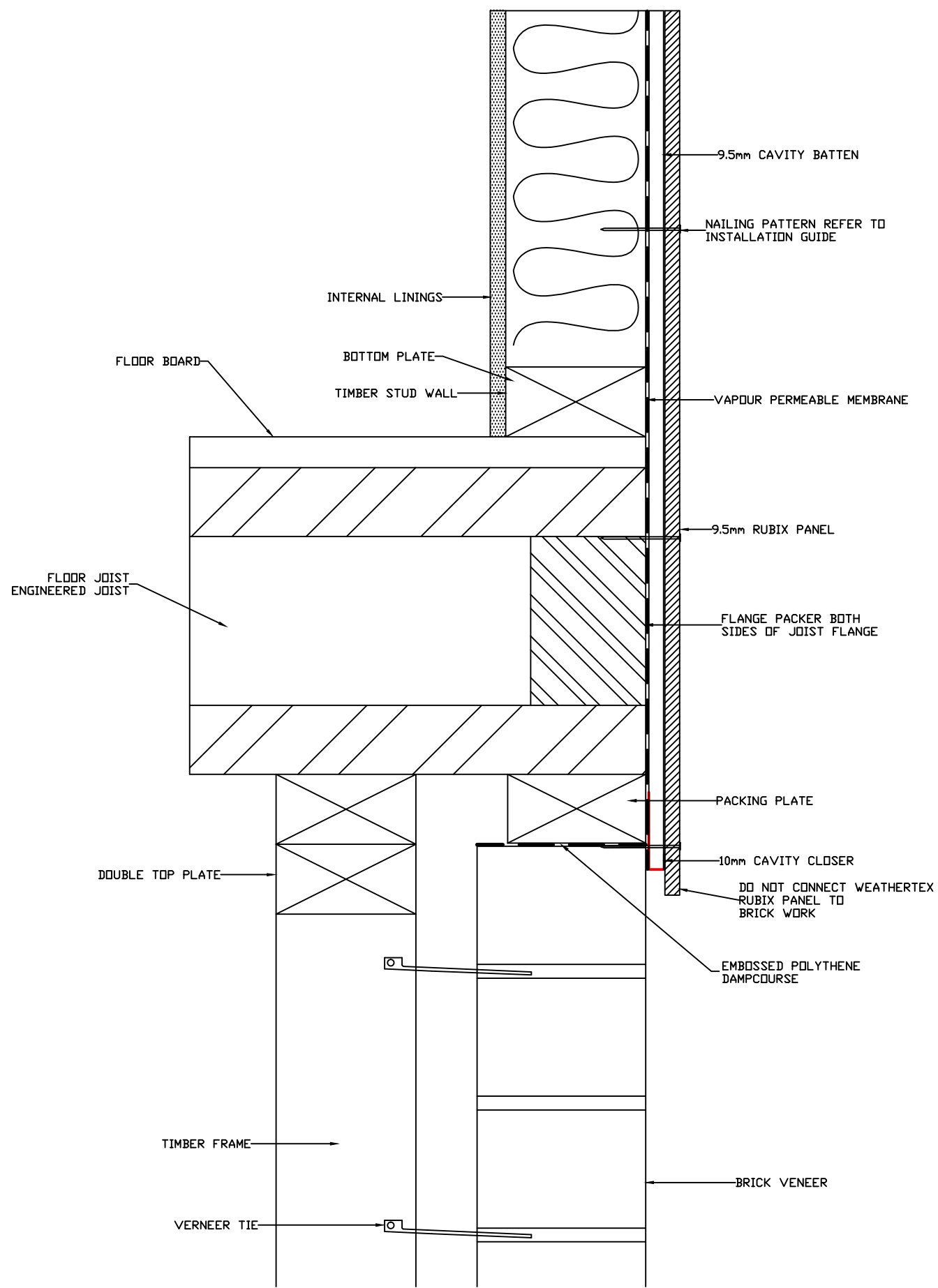

FLUSH WITH BRICK VENEER DETAIL

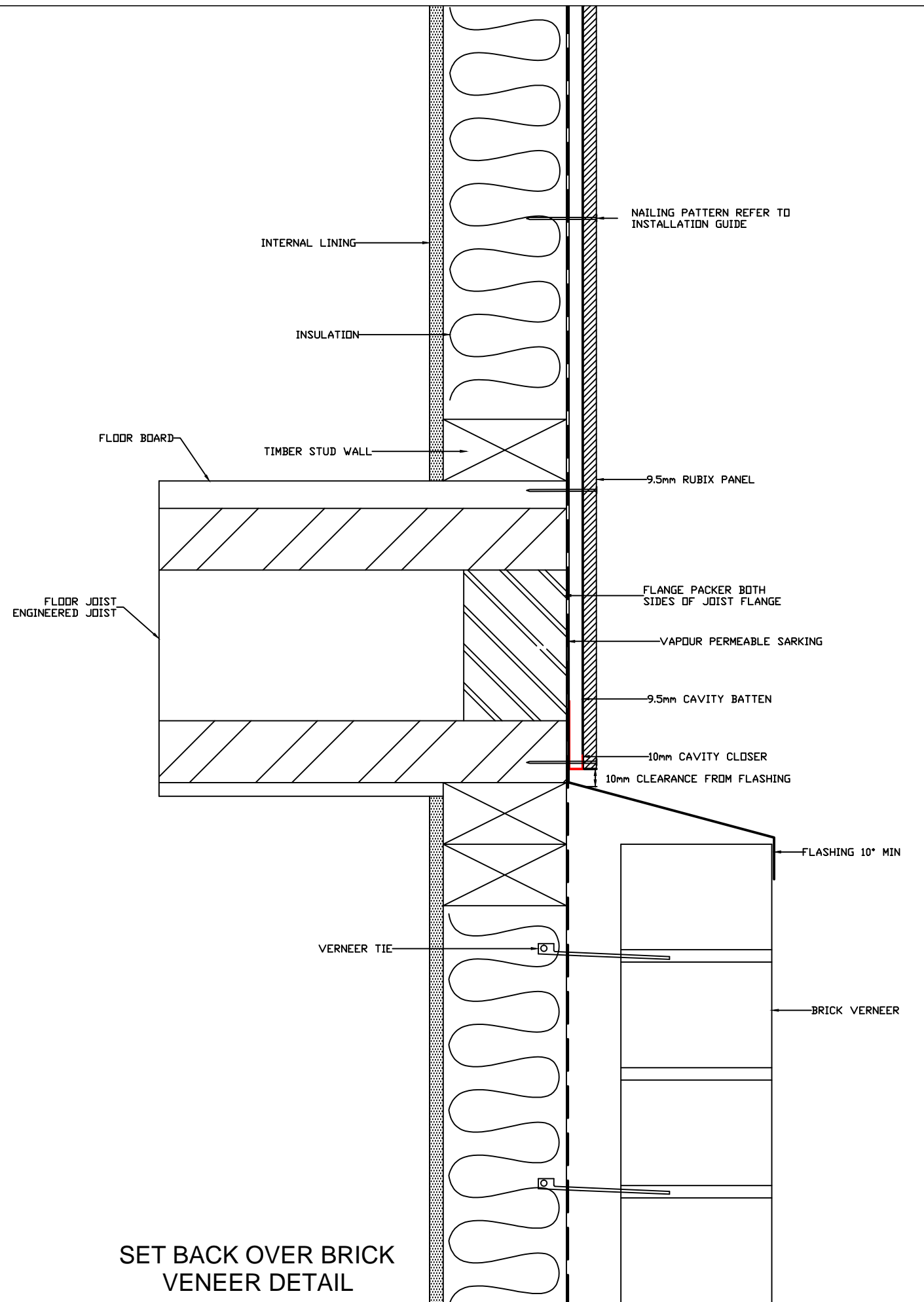

SET BACK OVER BRICK VENEER DETAIL



DRAWING NAME:  
9.5mm CAVITY INSTALLATION - ECOWALL

SCALE:  
NTS

DRAWN BY:  
A.MOATE

CHECKED BY:  
C.O'NEILL

DATE:  
26.10.17

DRAWING SET No.:  
CD-EW-C

SHT SIZE  
A3

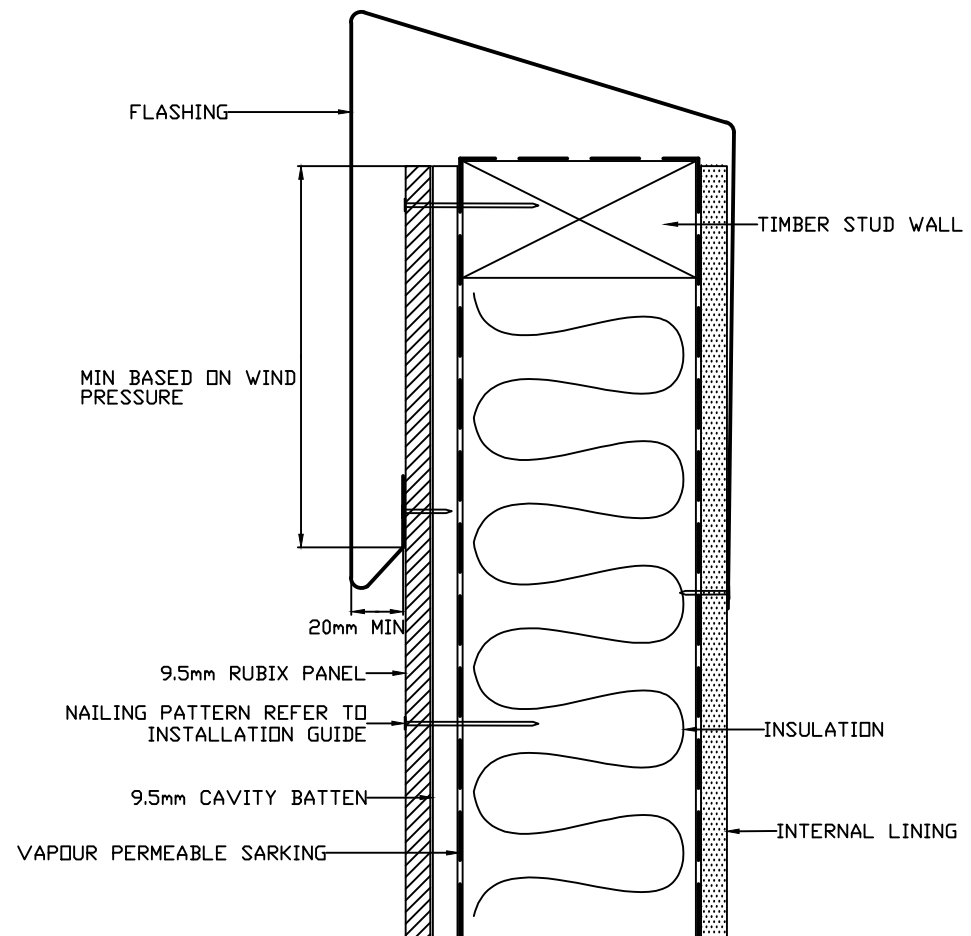

PARAPET DETAIL

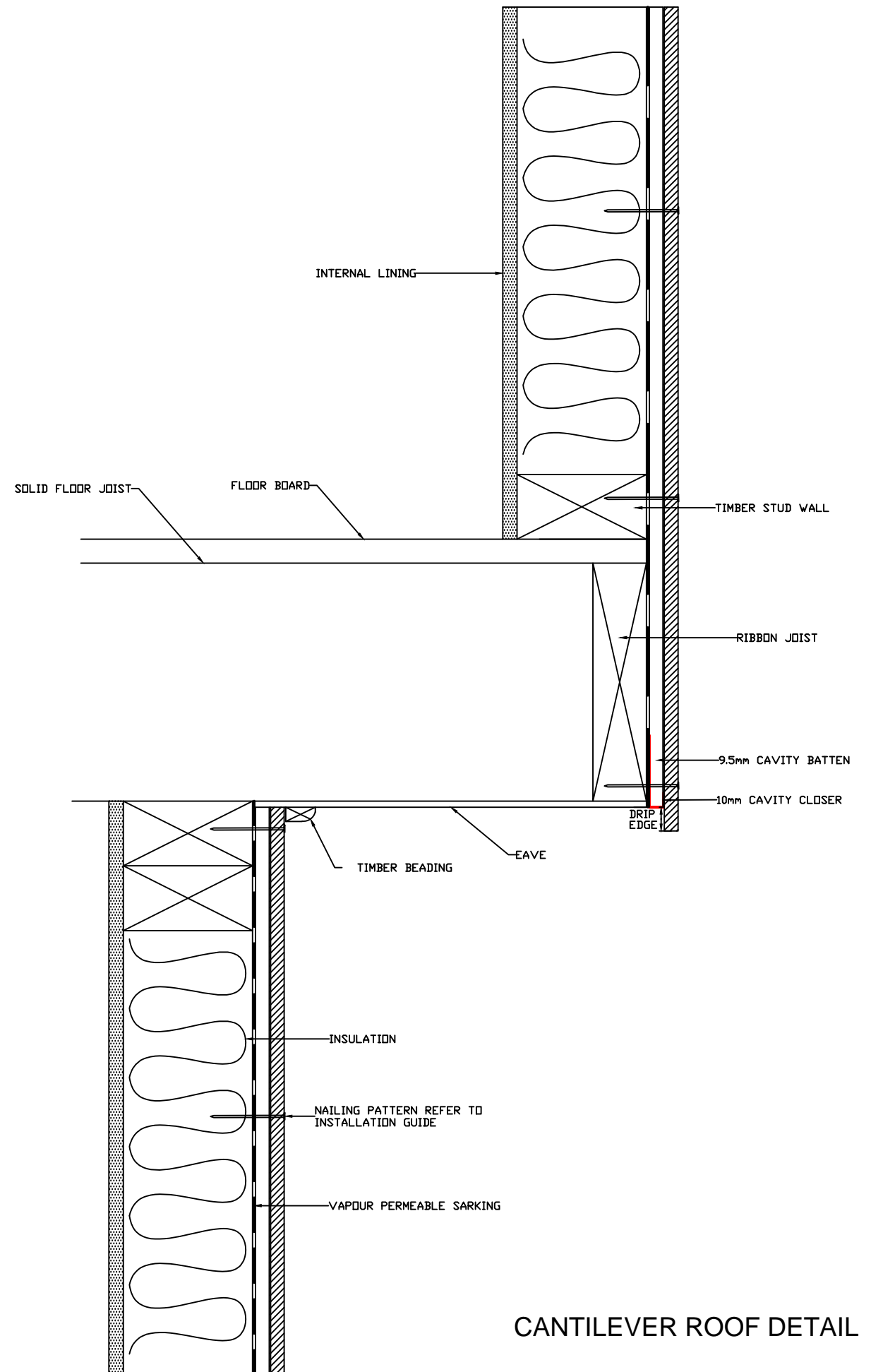

CANTILEVER ROOF DETAIL



DRAWING NAME:  
9.5mm CAVITY INSTALLATION - ECOWALL

SCALE:  
NTS

DRAWN BY:  
A.MOATE

CHECKED BY:  
C.O'NEILL

DATE:  
26.10.17

DRAWING SET No.:  
CD-EW-C

SHT SIZE  
A3

ROOF CLEARANCE DETAIL

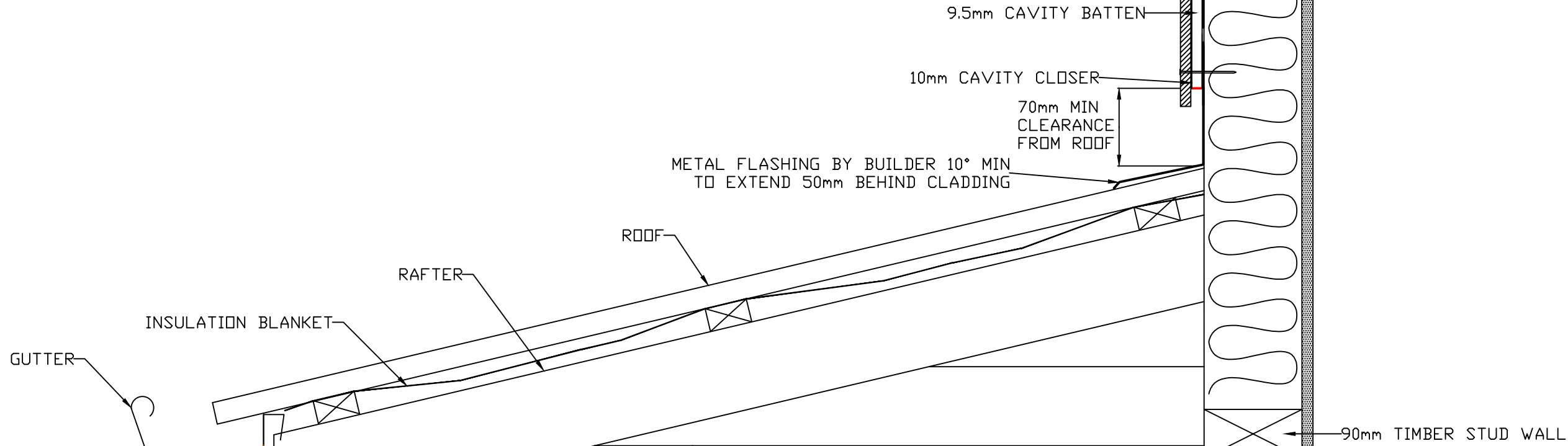

EAVE DETAIL

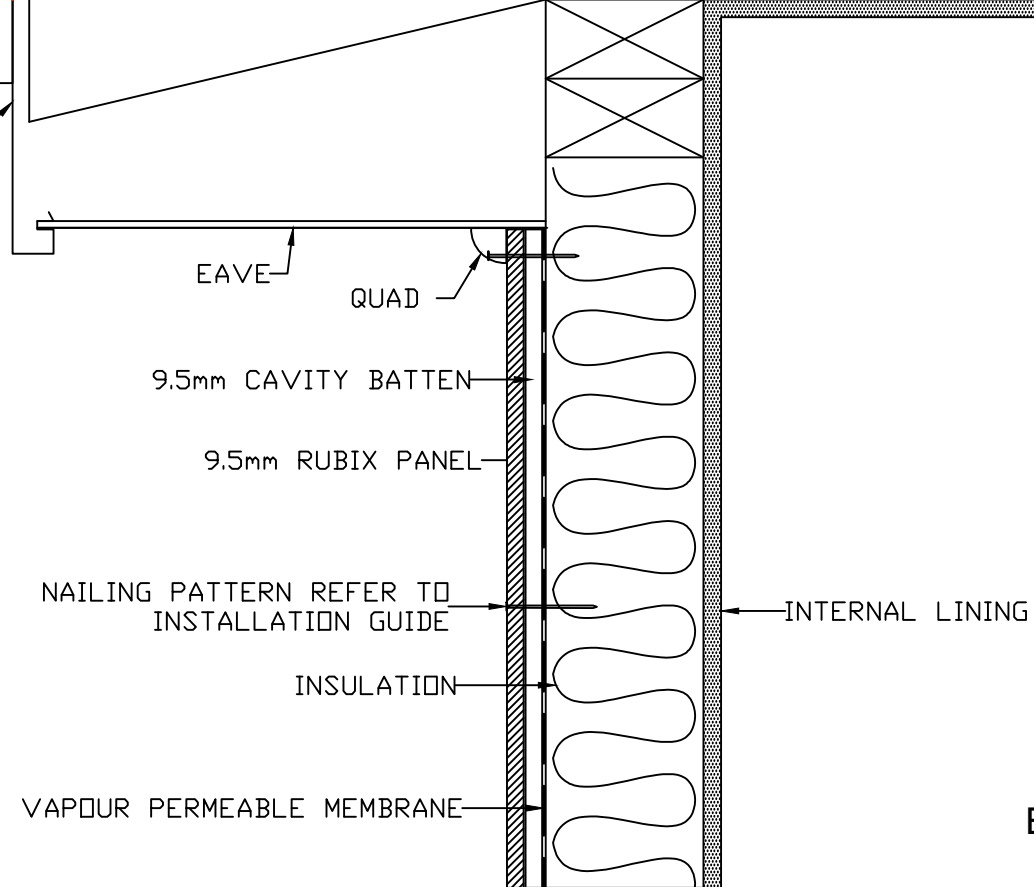

EAVE AND ROOF CLEARANCE DETAIL



DRAWING NAME:	SCALE:	DRAWN BY:	CHECKED BY:	DATE:	DRAWING SET No.:	SHT SIZE
9.5mm CAVITY INSTALLATION - ECOWALL	NTS	A.MOATE	C.O'NEILL	26.10.17	CD-EW-C	A3

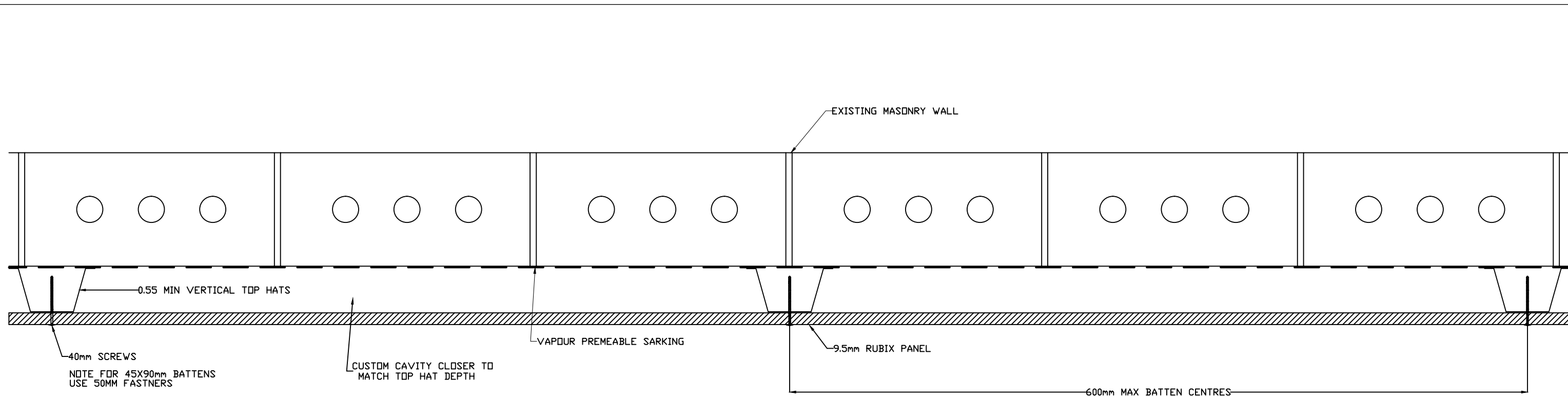

**CLADDING OVER MASONRY WITH  
METAL TOPHATS DETAIL**

NOTE: VERTICAL BATTENS ONLY

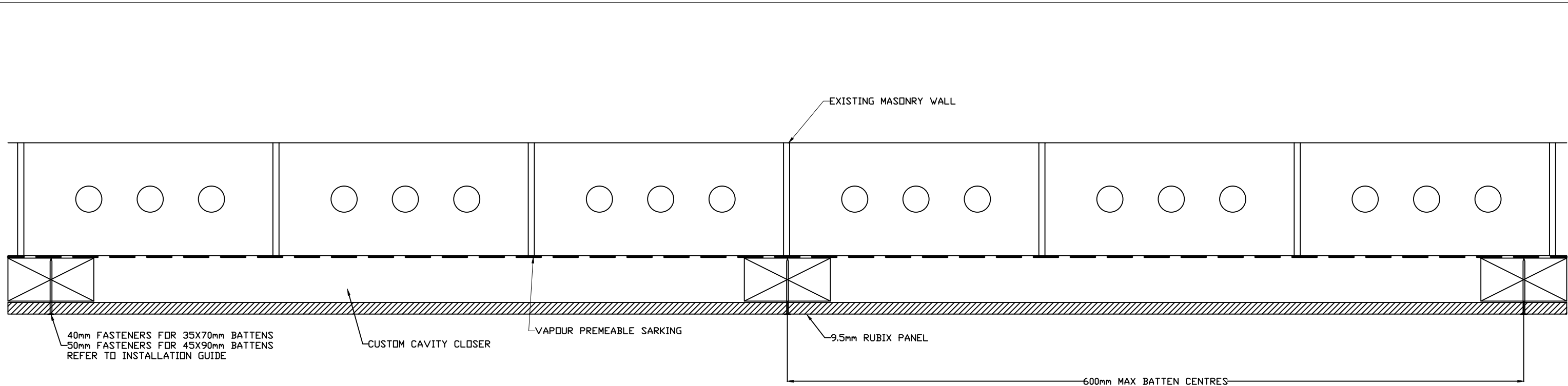

**CLADDING OVER BRICK WITH  
TIMBER BATTEN DETAIL**

NOTE: VERTICAL BATTENS ONLY