

WEATHERTEX CONSTRUCTION DETAIL GUIDE

ECOWALL PANELS

9.5mm CAVITY CONSTRUCTION

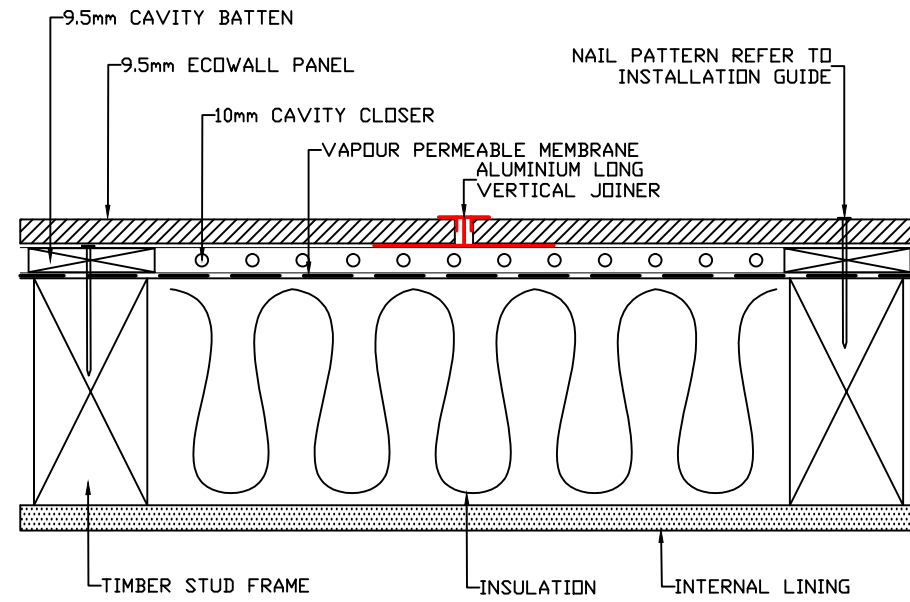



OFF STUD LONG VERTICAL JOINER DETAIL

NOTE: VERTICAL JOINT SUPPORTED BY 600mm DWANGS/NOGGINS

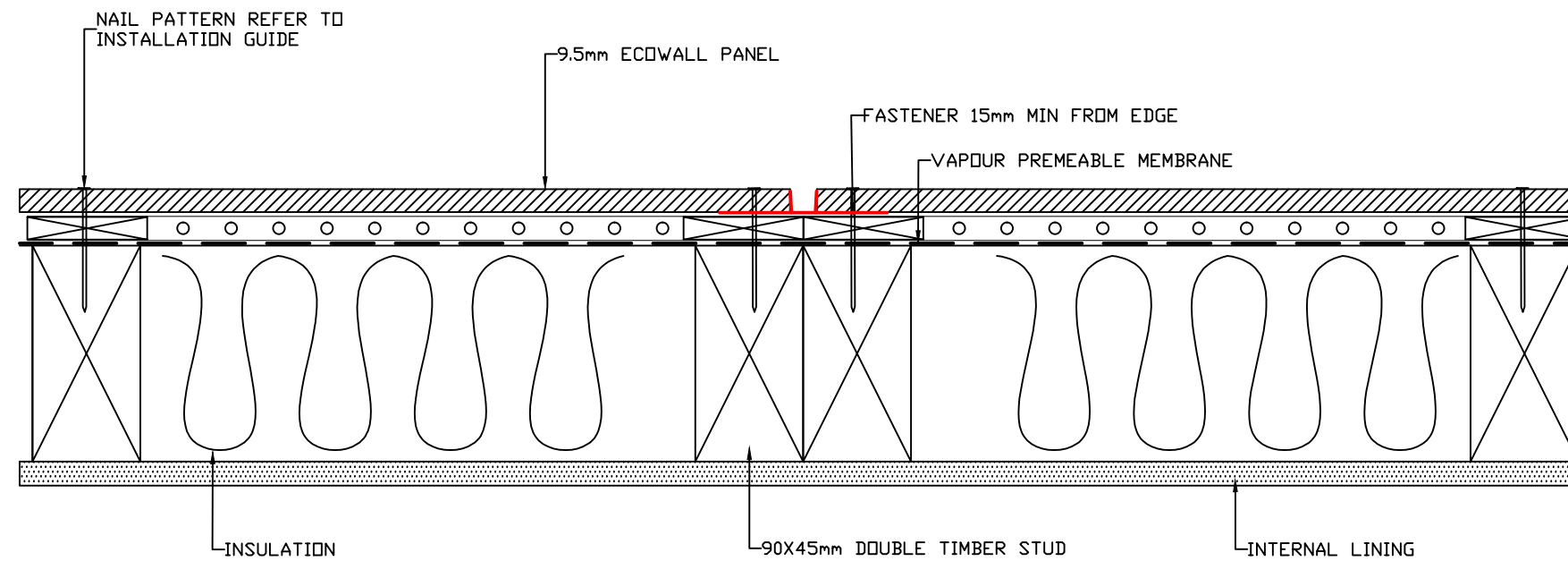

ON STUD DEEP CHANNEL JOIN DETAIL



DRAWING NAME:

9.5mm CAVITY INSTALLATION - ECOWALL

SCALE:

NTS

DRAWN BY:

A.MOATE

CHECKED BY:

C.O'NEILL

DATE:

26.10.17

DRAWING SET No.:

CD-EW-C

SHT SIZE

A3

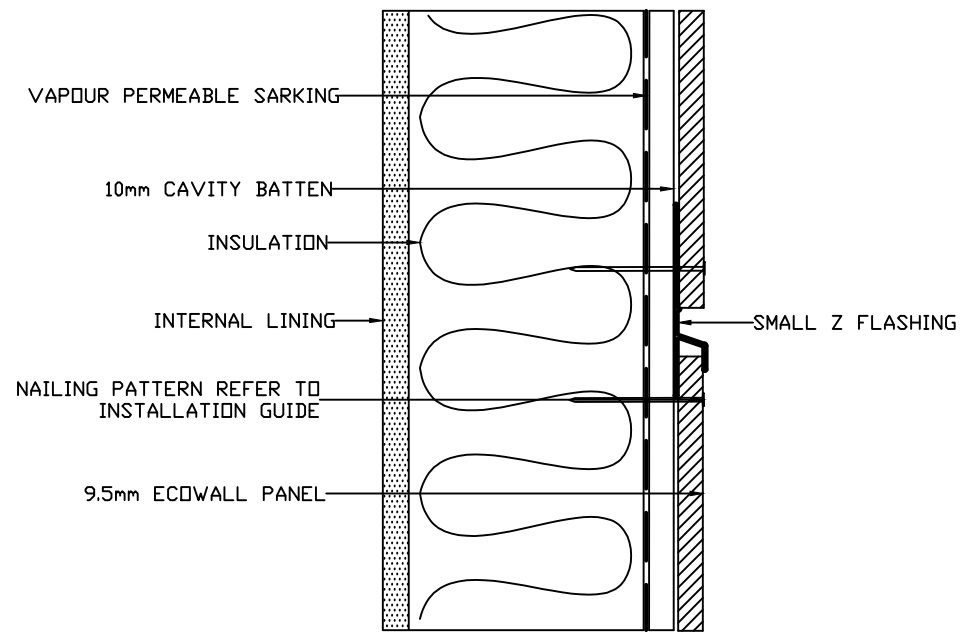

SMALL Z FLASHING JOIN DETAIL

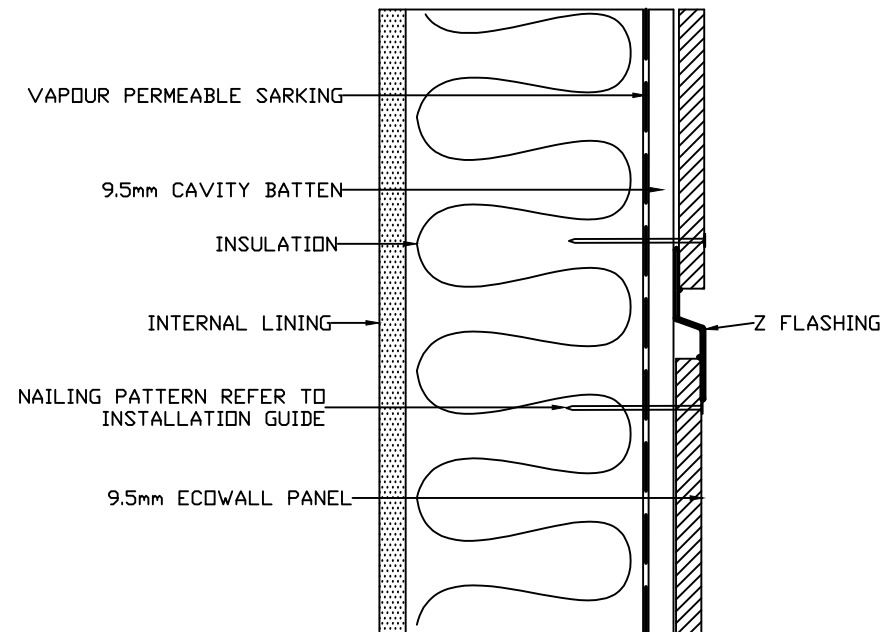

Z FLASHING JOIN DETAIL

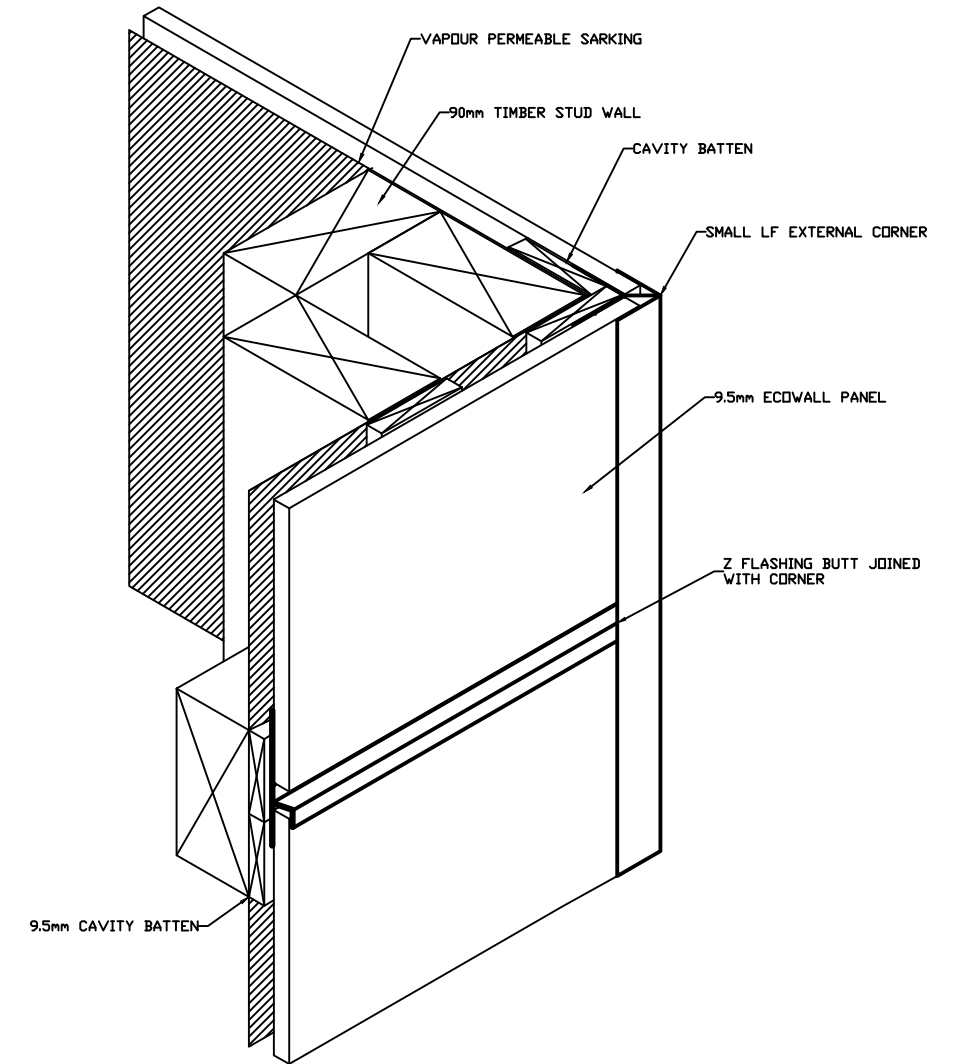

Z FLASHING INTO CORNER DETAIL



DRAWING NAME:
9.5mm CAVITY INSTALLATION - ECOWALL

SCALE:
NTS

DRAWN BY:
A.MOATE

CHECKED BY:
C.O'NEILL

DATE:
26.10.17

DRAWING SET No.:
CD-EW-C

SHT SIZE
A3

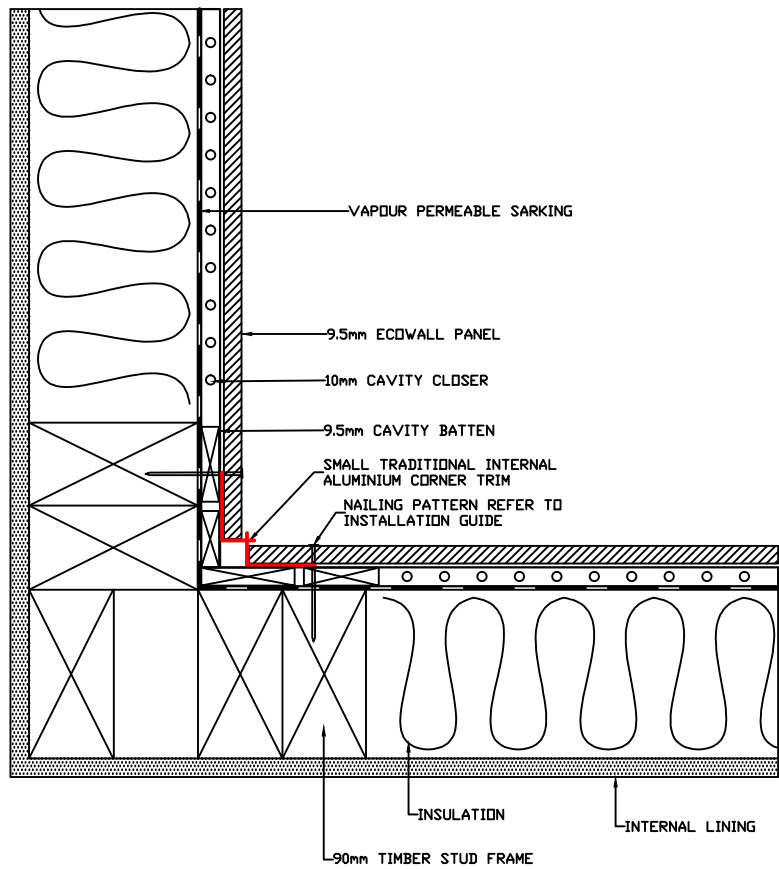

SMALL TRADITIONAL INTERNAL "W" CORNER DETAIL

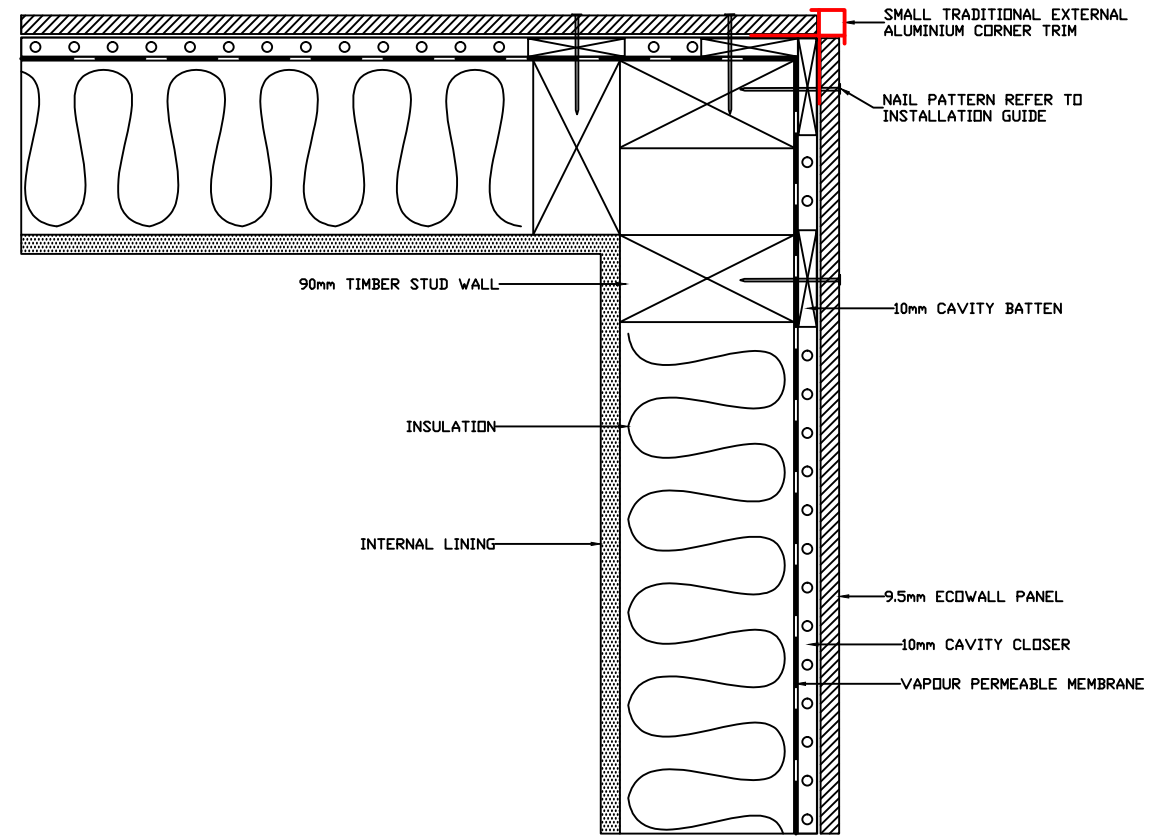

SMALL TRADITIONAL EXTERNAL "BOX" CORNER DETAIL

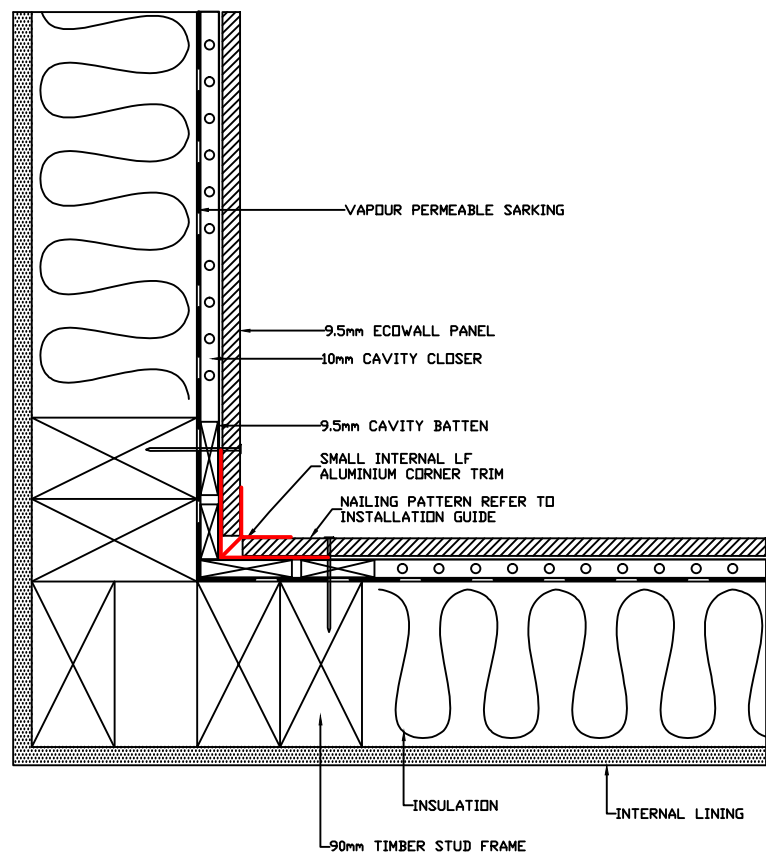

SMALL INTERNAL LF CORNER DETAIL

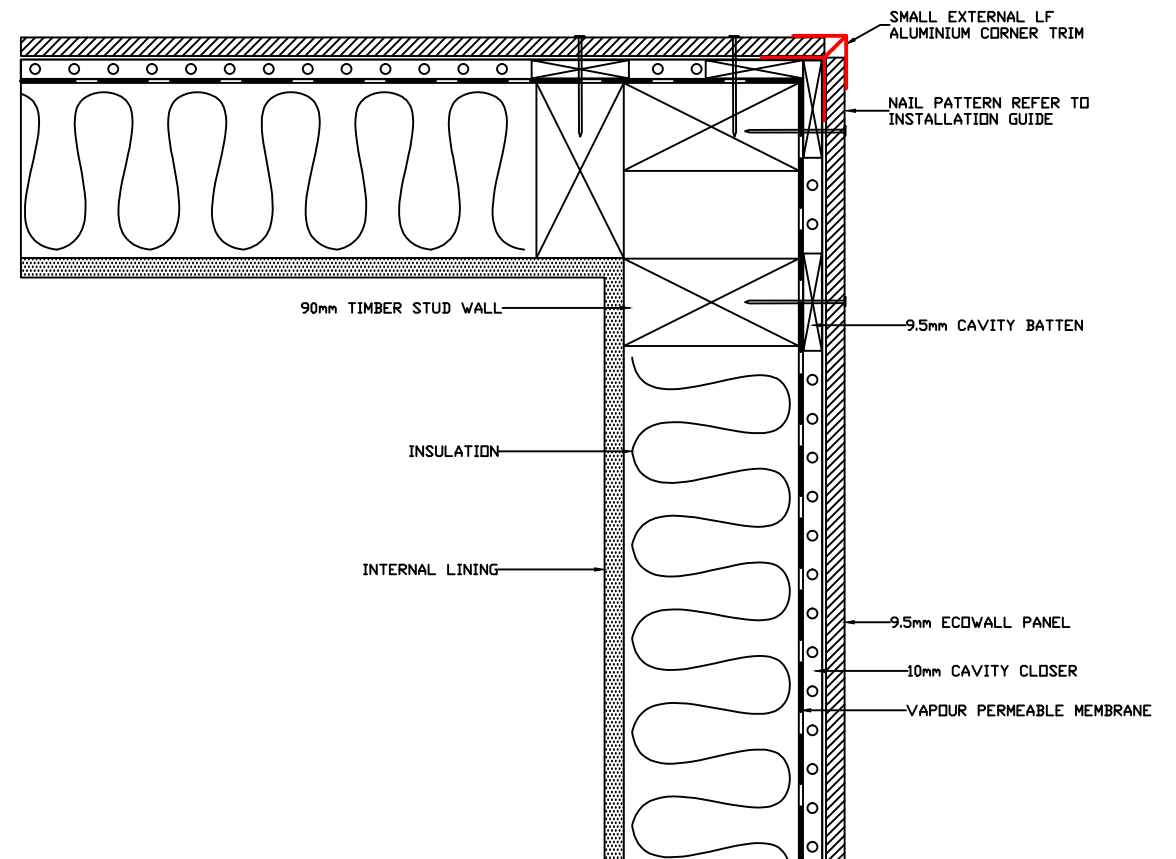

SMALL EXTERNAL LF CORNER DETAIL



DRAWING NAME:
9.5mm CAVITY INSTALLATION - ECOWALL

SCALE:
NTS

DRAWN BY:
A.MOATE

CHECKED BY:
C.O'NEILL

DATE:
26.10.17

DRAWING SET No.:
CD-EW-C

SHT SIZE
A3

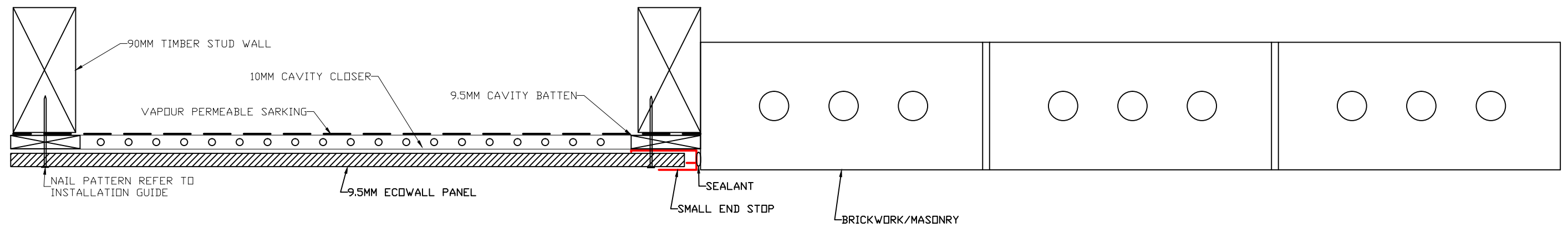

END STOP TO MASONRY BRICK DETAIL



DRAWING NAME:	SCALE:	DRAWN BY:	CHECKED BY:	DATE:	DRAWING SET No.:	SHT SIZE
9.5mm CAVITY INSTALLATION - ECOWALL	NTS	A.MOATE	C.O'NEILL	26.10.17	CD-EW-C	A3

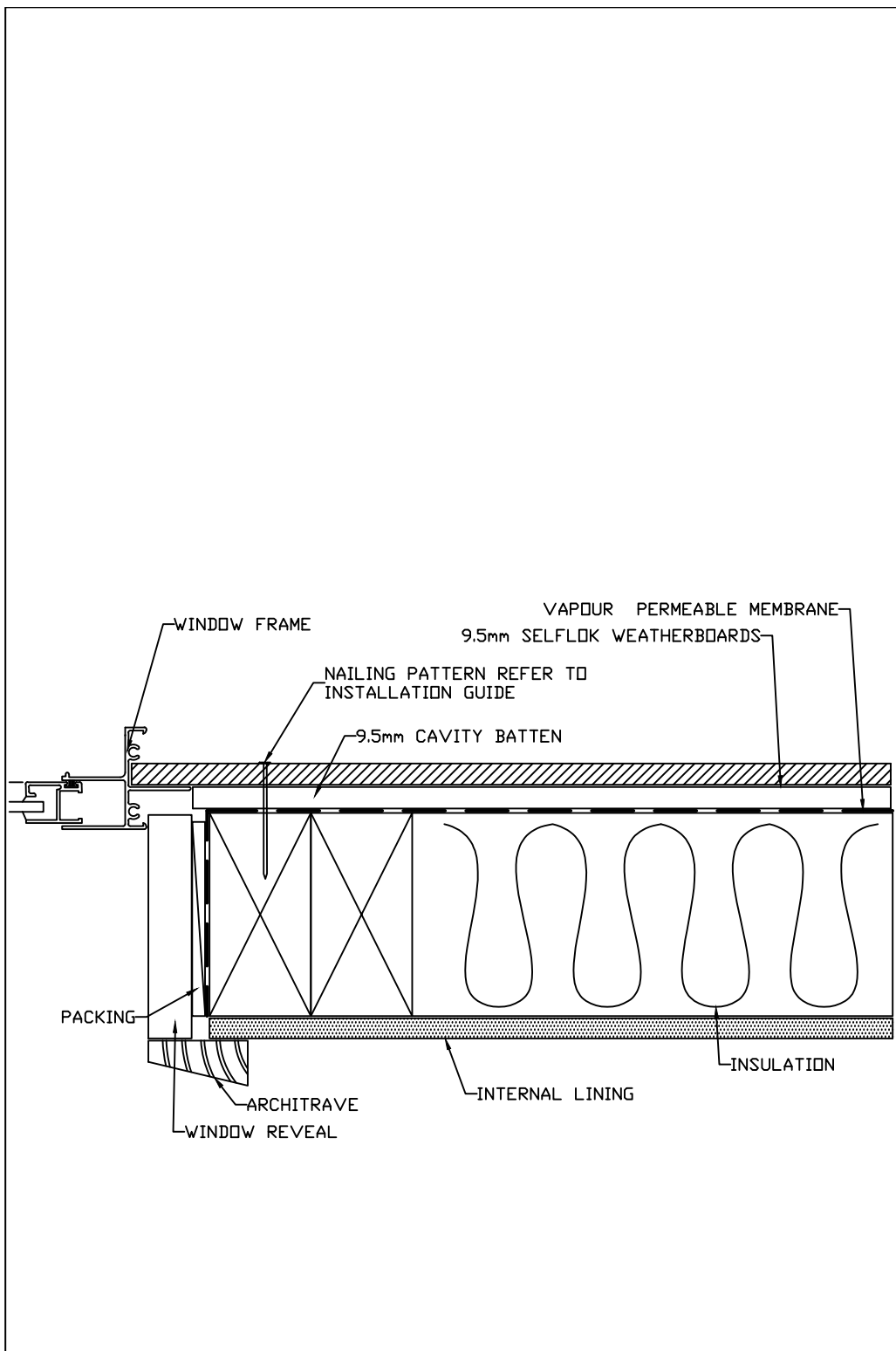

WINDOW JAMB DETAIL

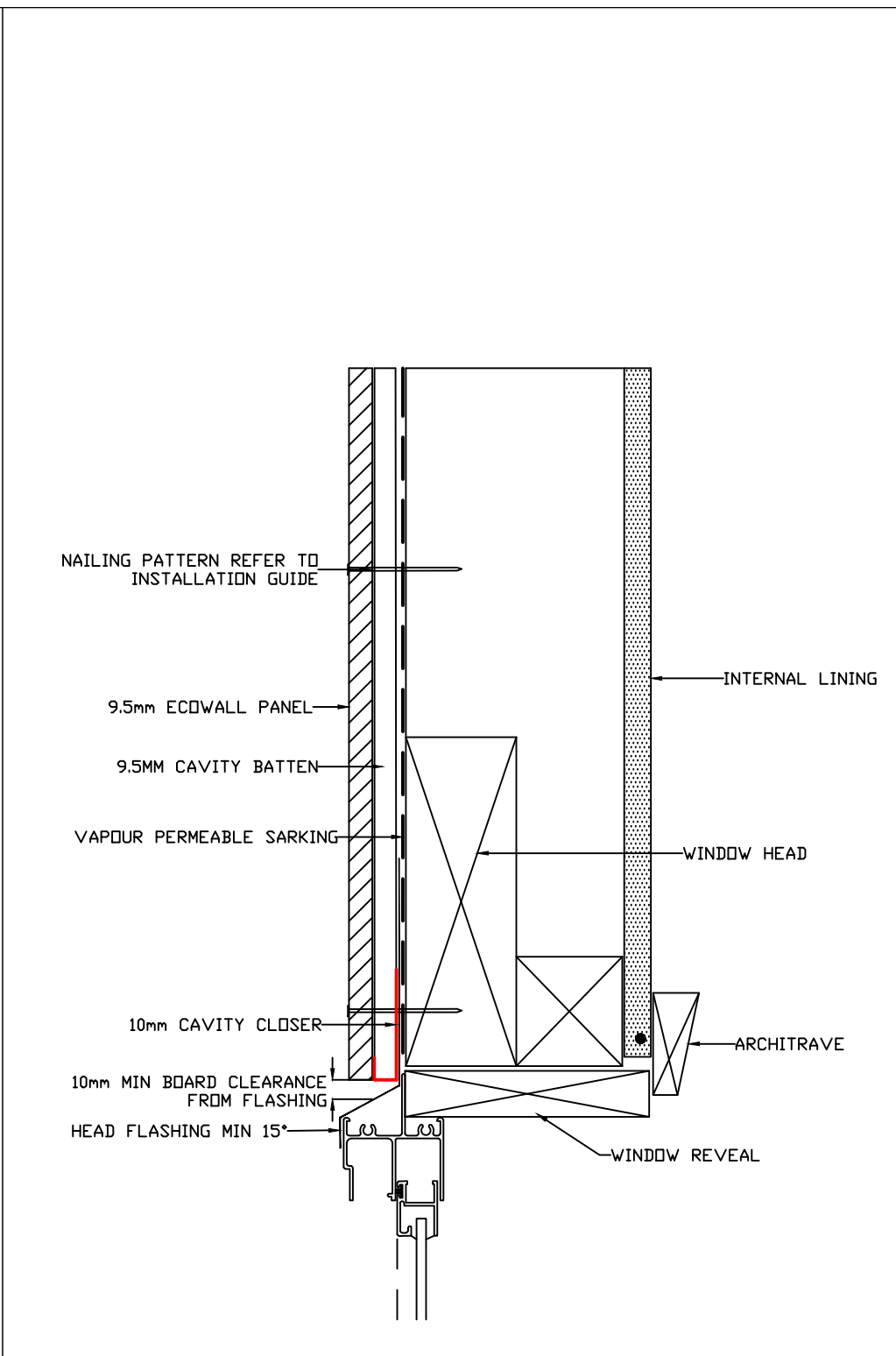

WINDOW HEAD DETAIL

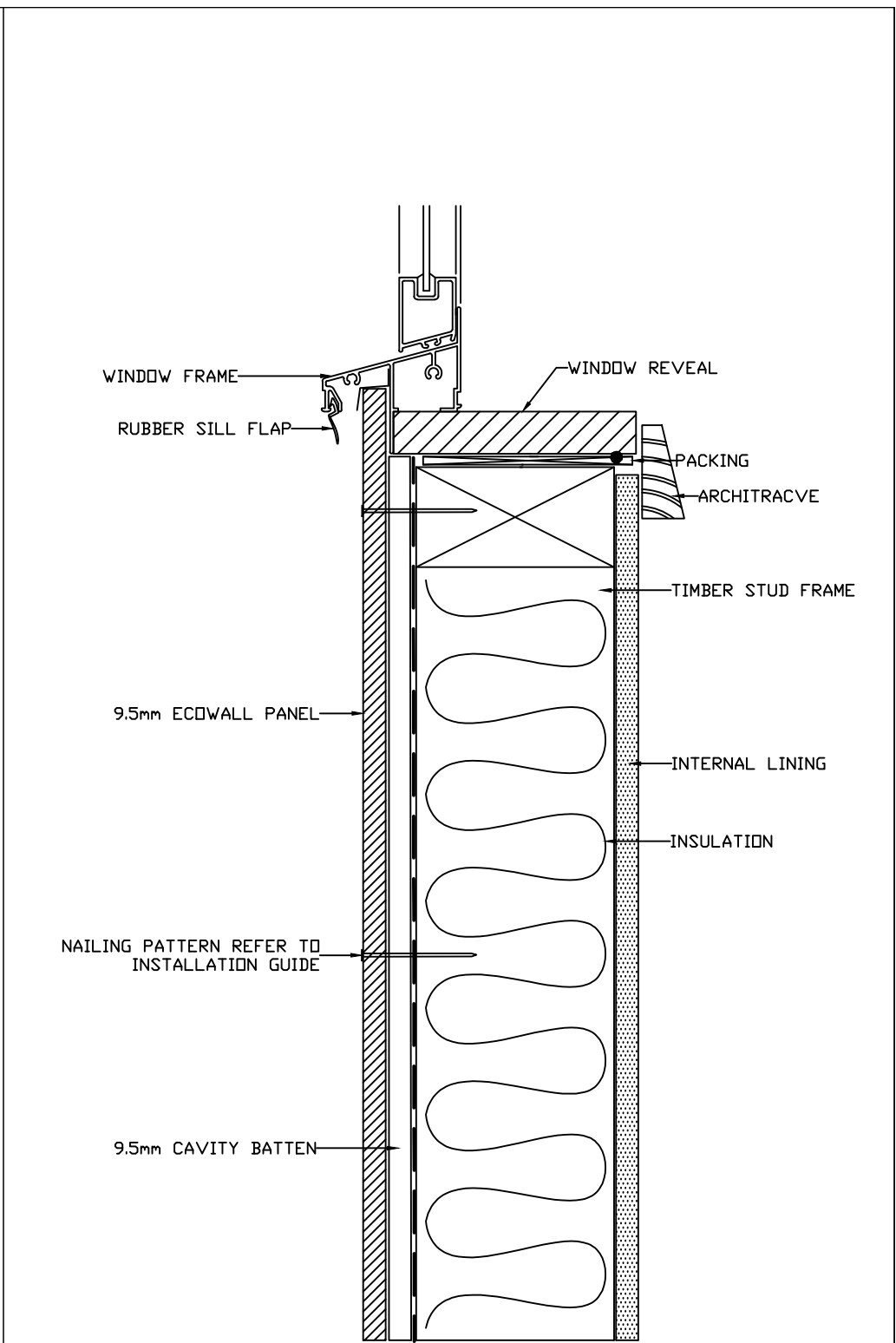

WINDOW SILL DETAIL

	DRAWING NAME:	SCALE:	DRAWN BY:	CHECKED BY:	DATE:	DRAWING SET No.:	SHT SIZE
	9.5mm CAVITY INSTALLATION - ECOWALL	NTS	A.MOATE	C.O'NEILL	26.10.17	CD-EW-C	A3

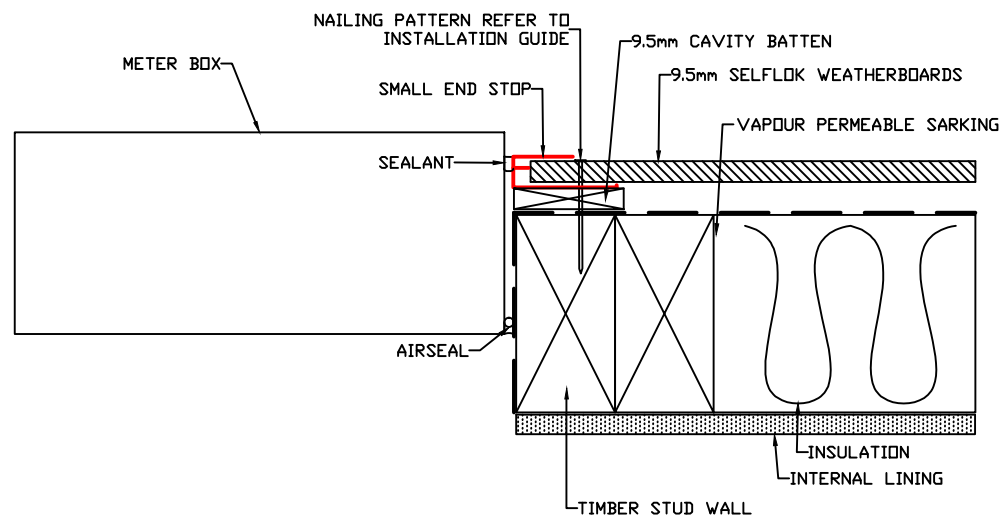

METER BOX JAMB
DETAIL

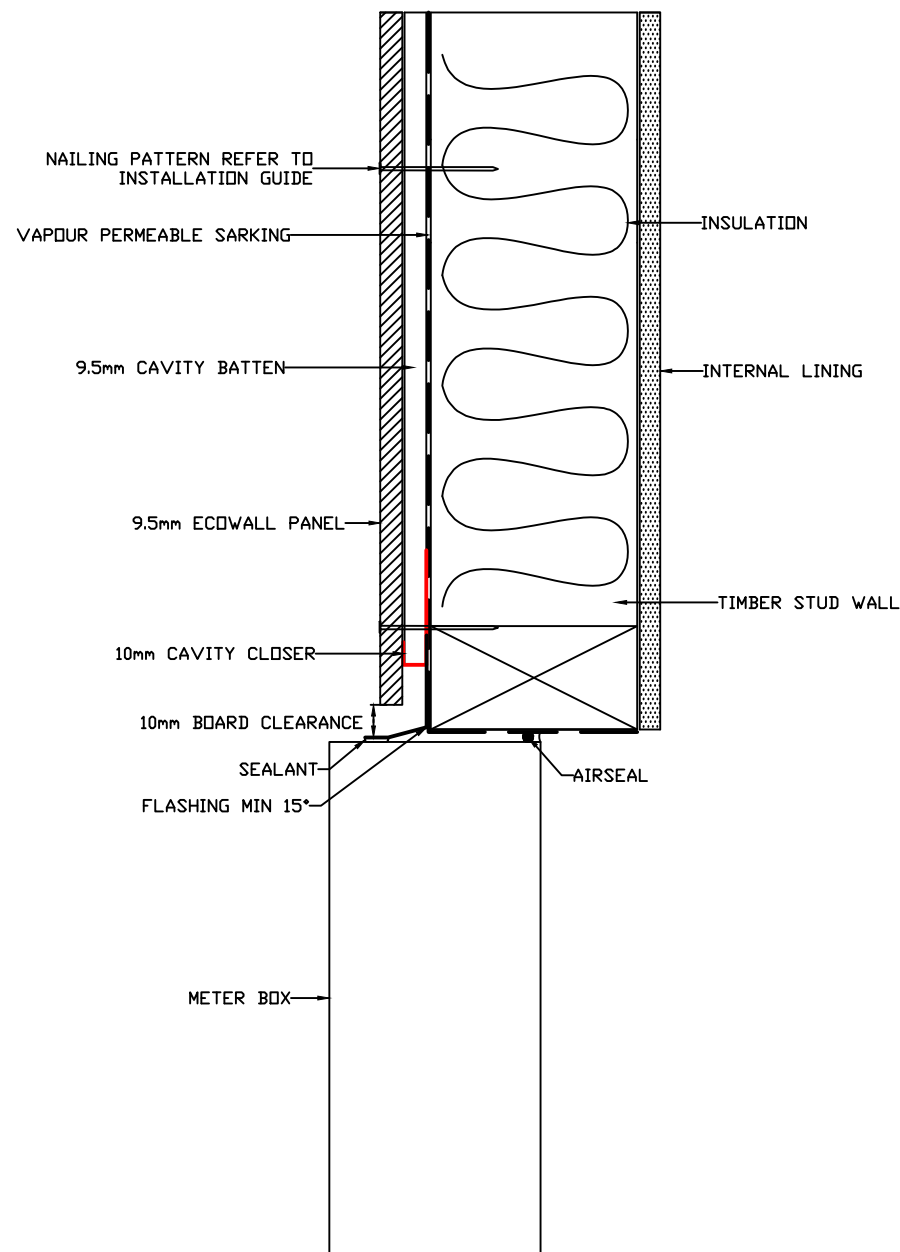

METER BOX HEAD
DETAIL

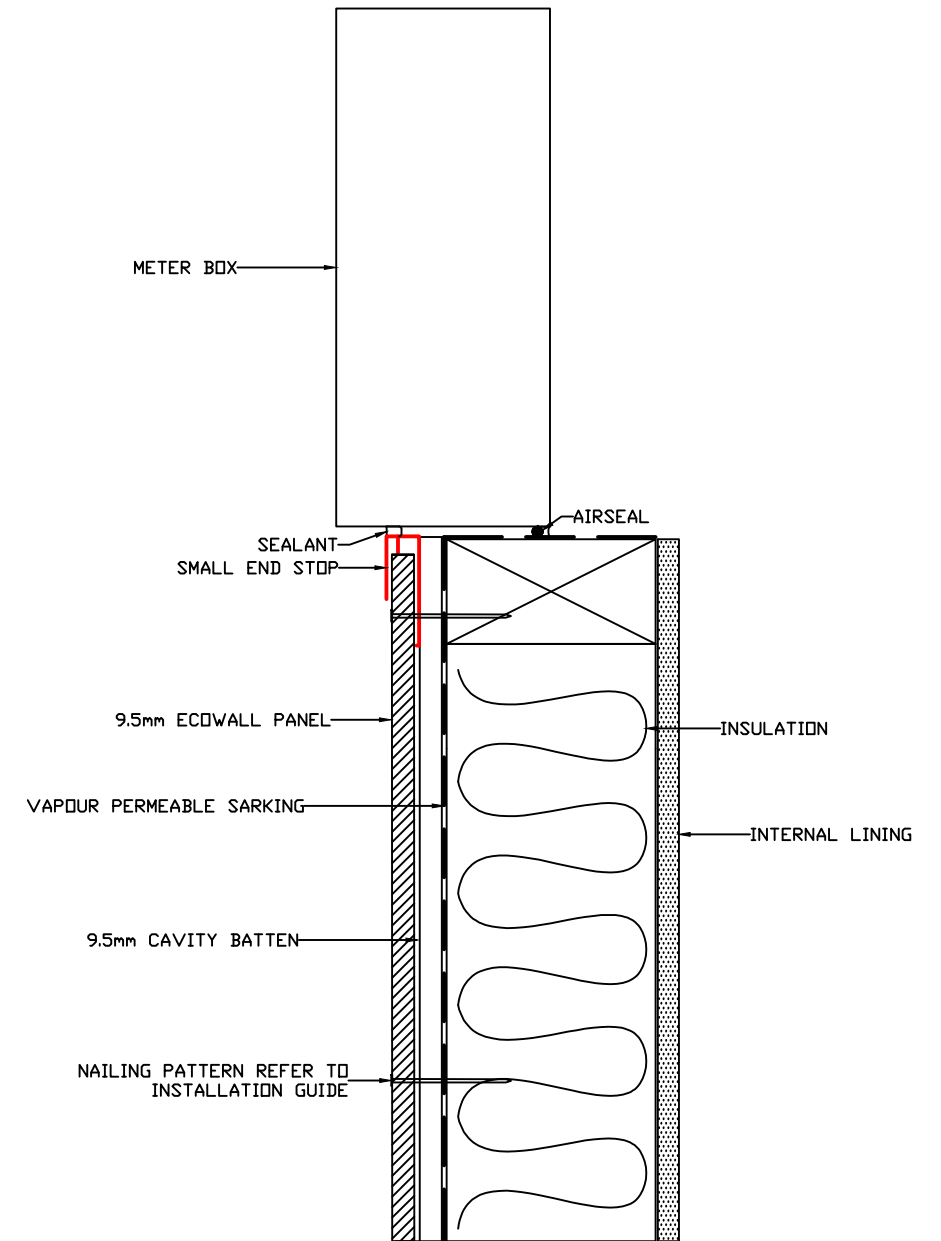

METER BOX SILL
DETAIL

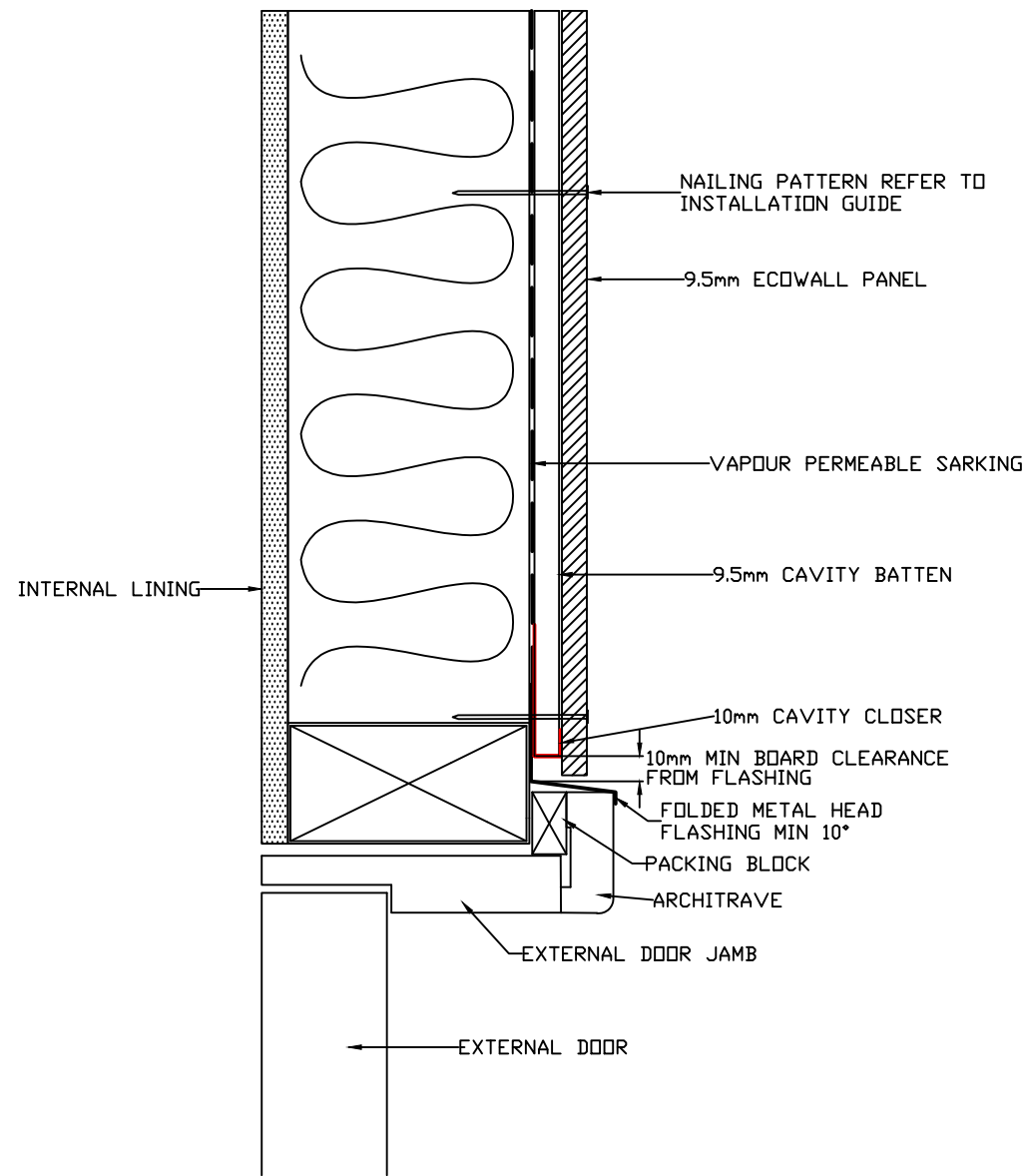

DOOR HEADER DETAIL

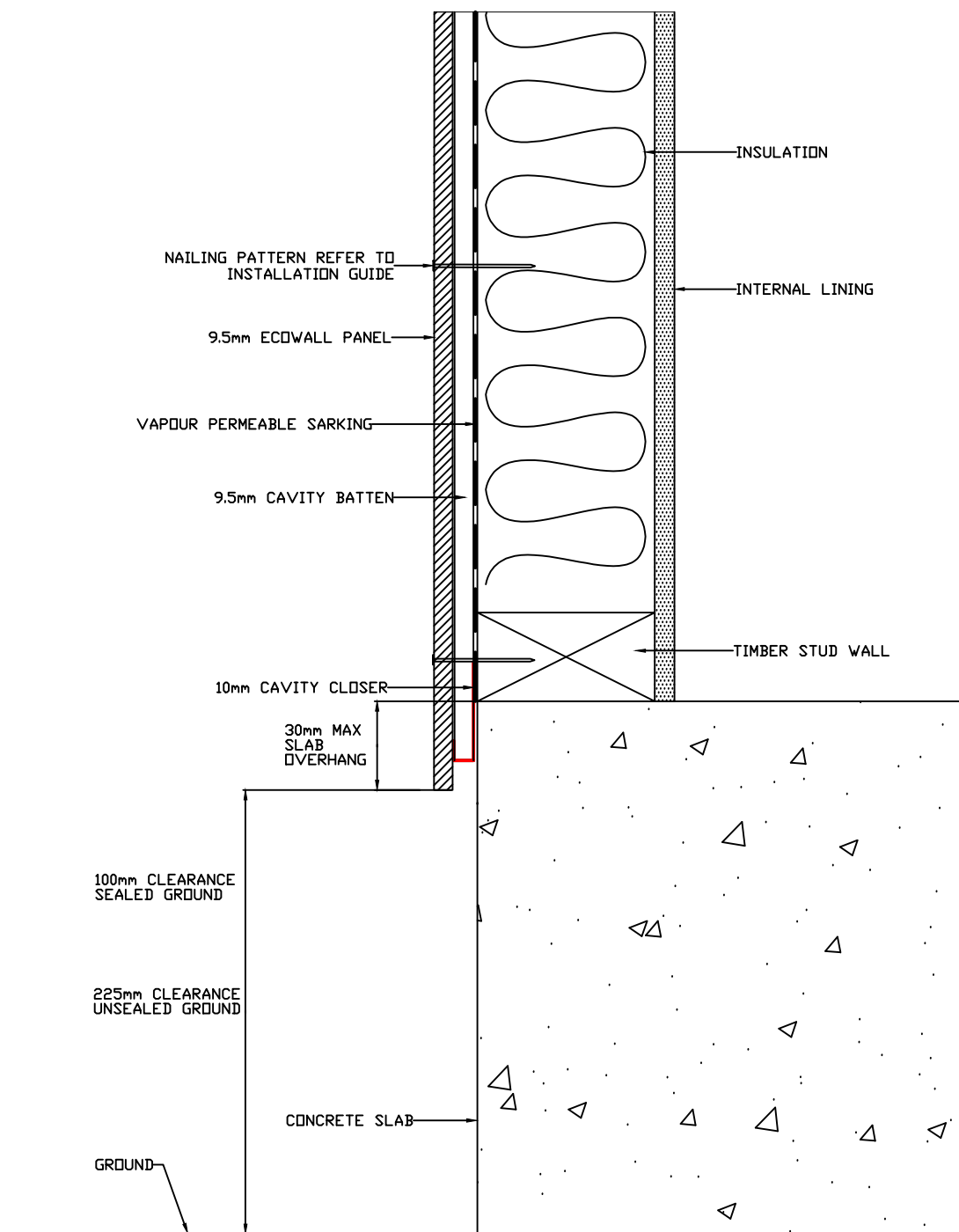

CONCRETE SLAB
GROUND CLEARANCE DETAIL

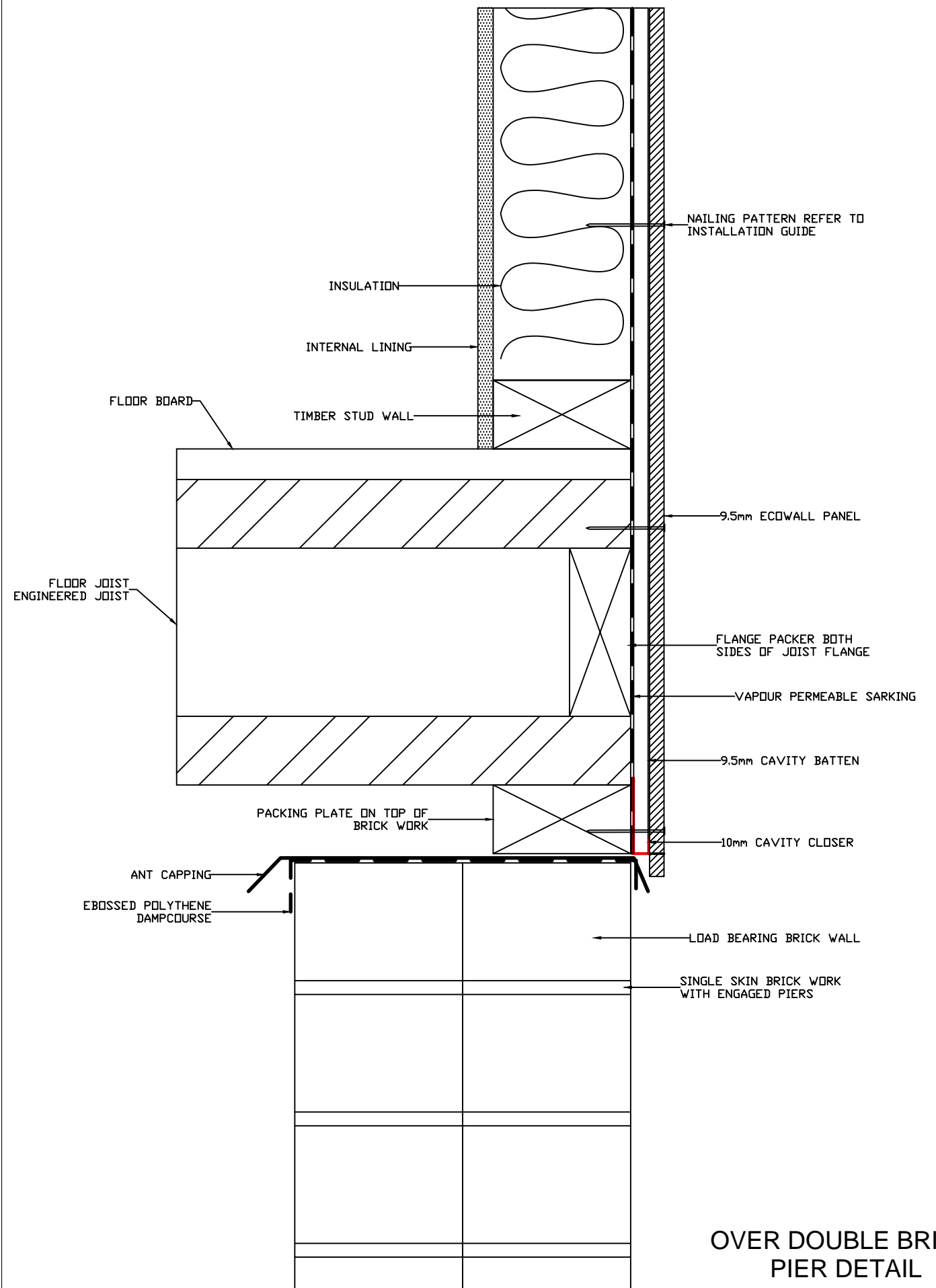

OVER DOUBLE BRICK
PIER DETAIL

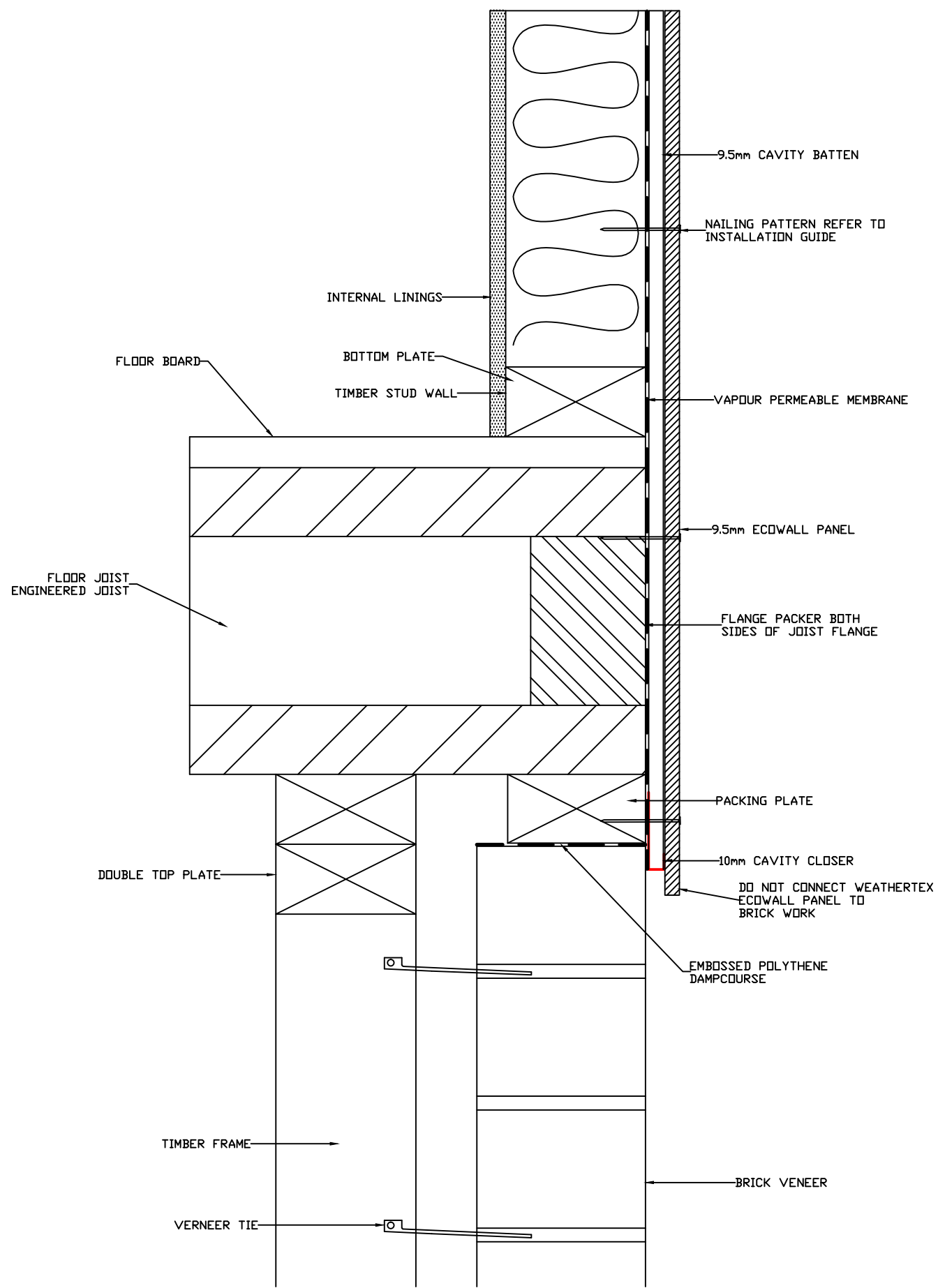

FLUSH WITH BRICK VENEER DETAIL

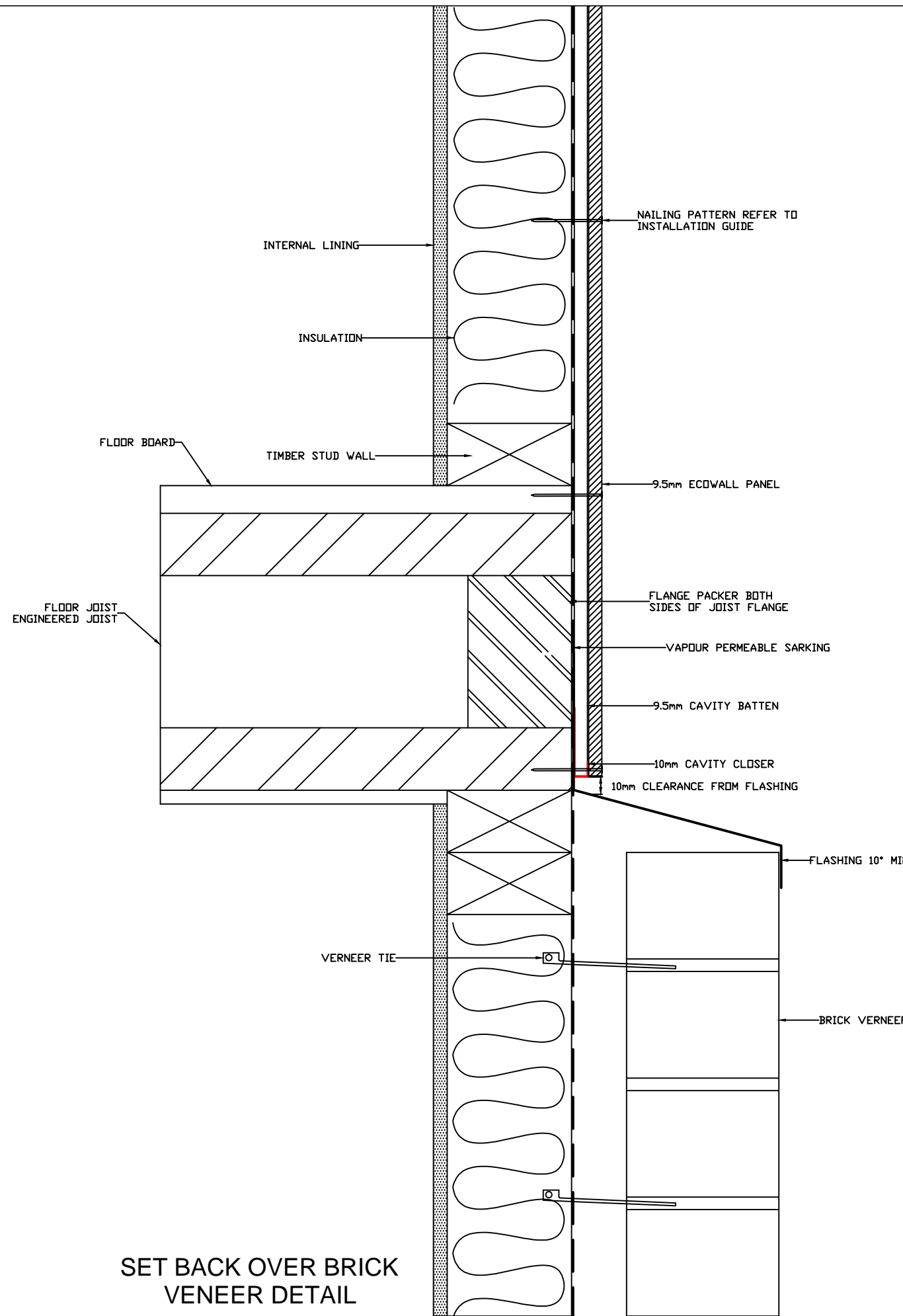

SET BACK OVER BRICK VENEER DETAIL



DRAWING NAME:
9.5mm CAVITY INSTALLATION - ECOWALL

SCALE:
NTS

DRAWN BY:
A.MOATE

CHECKED BY:
C.O'NEILL

DATE:
26.10.17

DRAWING SET No.:
CD-EW-C

SHT SIZE
A3

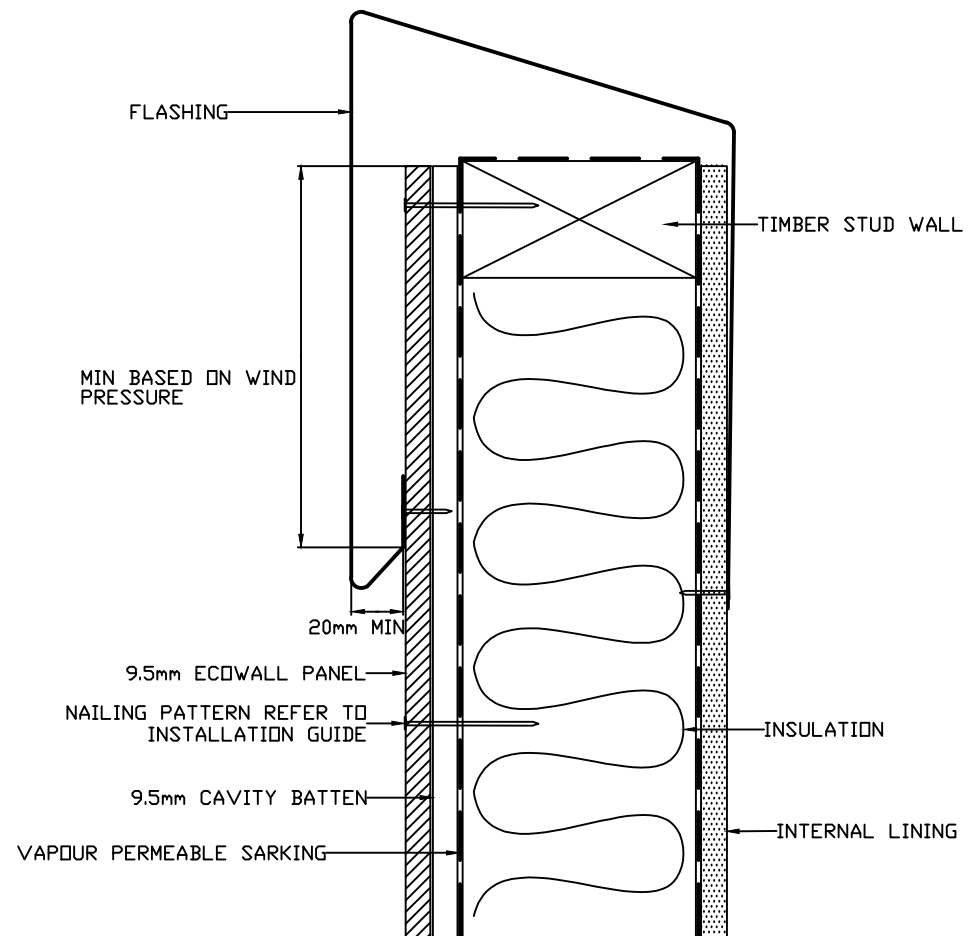

PARAPET DETAIL

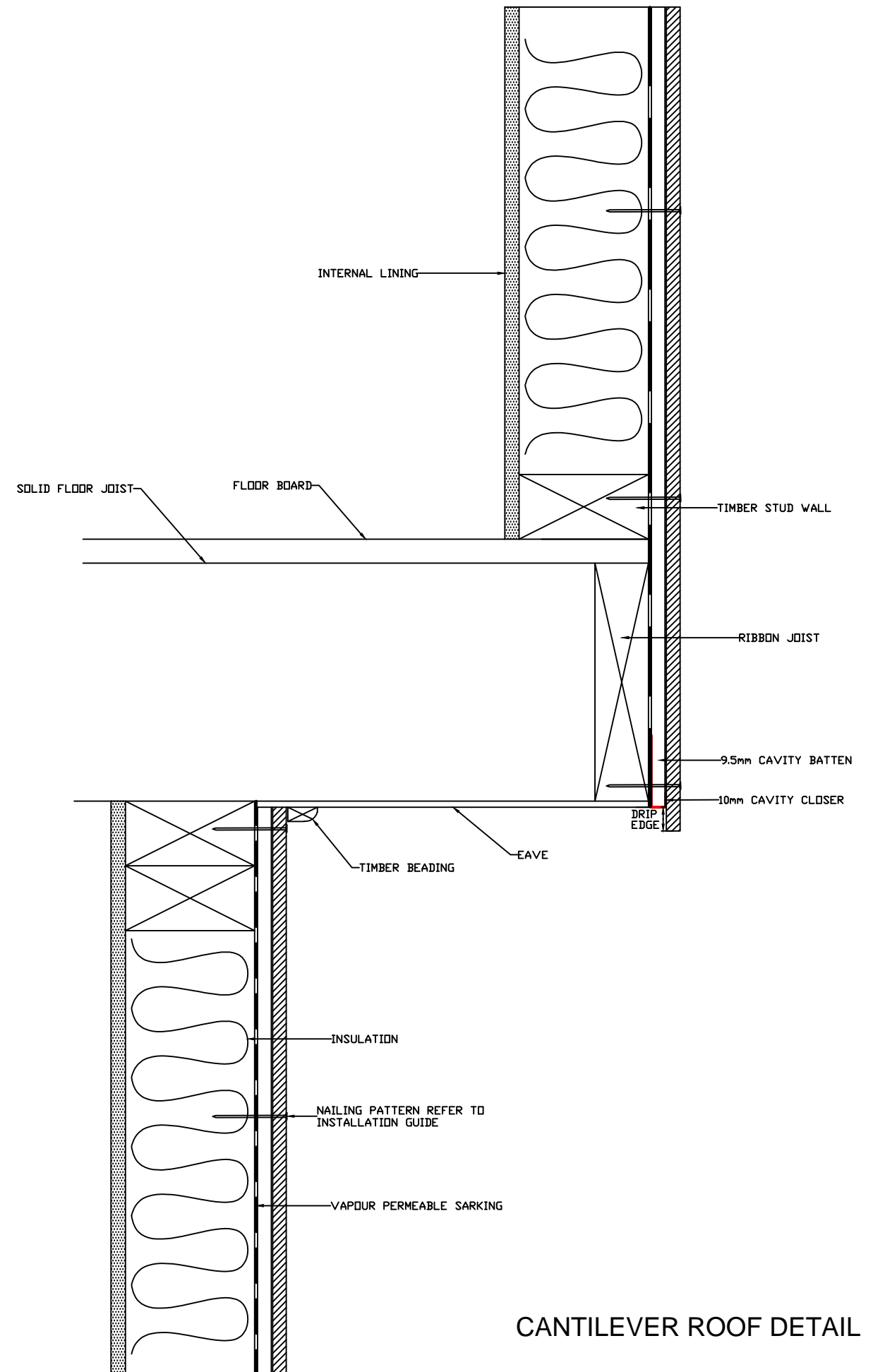

CANTILEVER ROOF DETAIL



DRAWING NAME:
9.5mm CAVITY INSTALLATION - ECOWALL

SCALE:
NTS

DRAWN BY:
A.MOATE

CHECKED BY:
C.O'NEILL

DATE:
26.10.17

DRAWING SET No.:
CD-EW-C

SHT SIZE
A3

ROOF CLEARANCE DETAIL

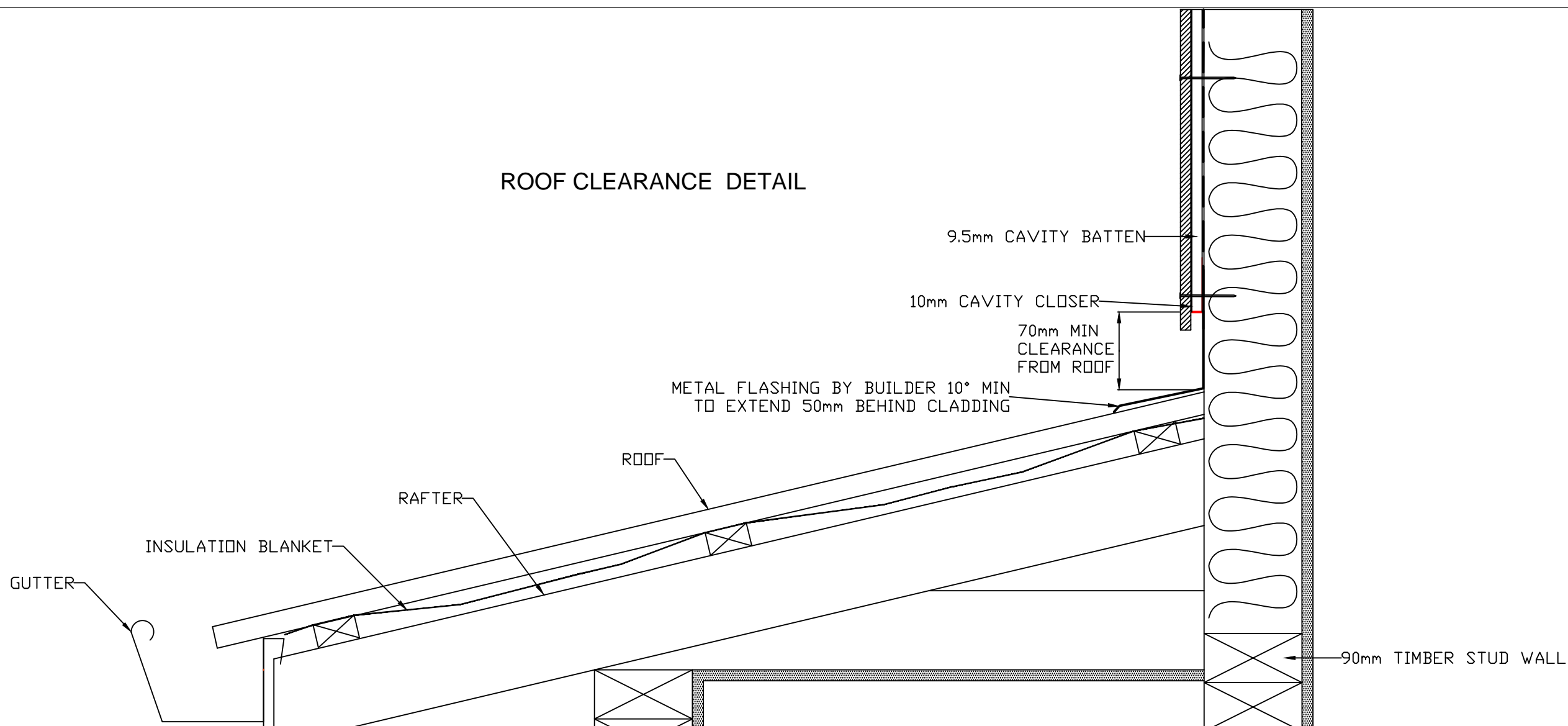

EAVE DETAIL

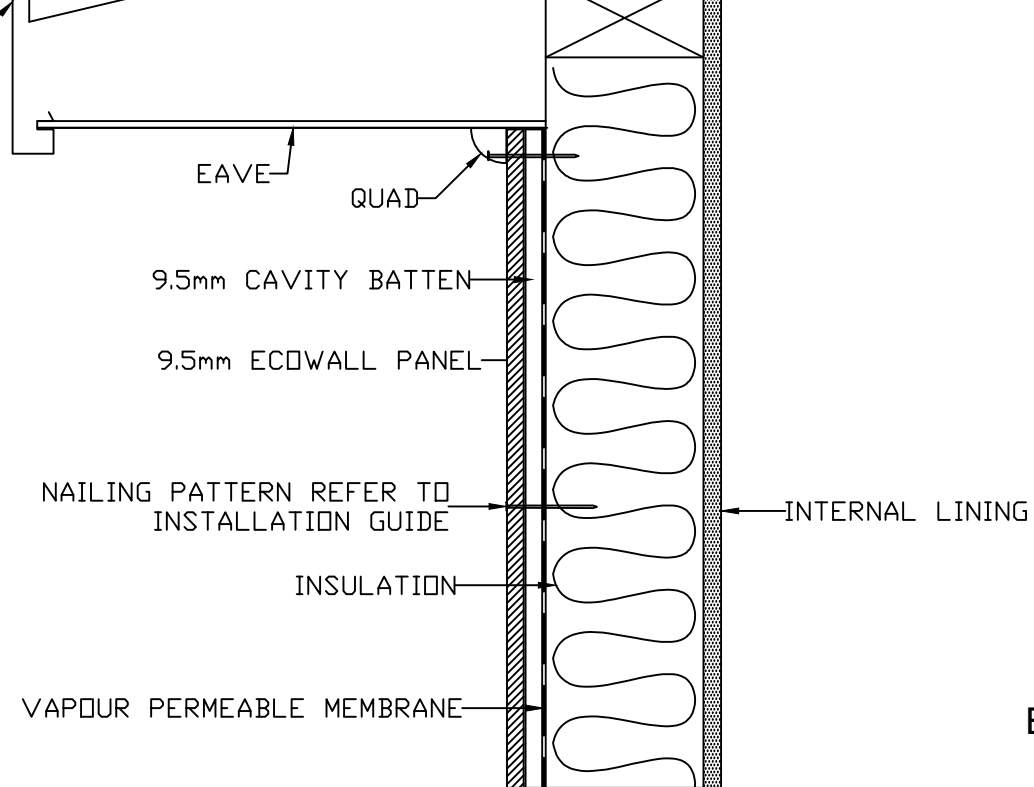

EAVE AND ROOF CLEARANCE DETAIL



DRAWING NAME:	SCALE:	DRAWN BY:	CHECKED BY:	DATE:	DRAWING SET No.:	SHT SIZE
9.5mm CAVITY INSTALLATION - ECOWALL	NTS	A.MOATE	C.O'NEILL	26.10.17	CD-EW-C	A3

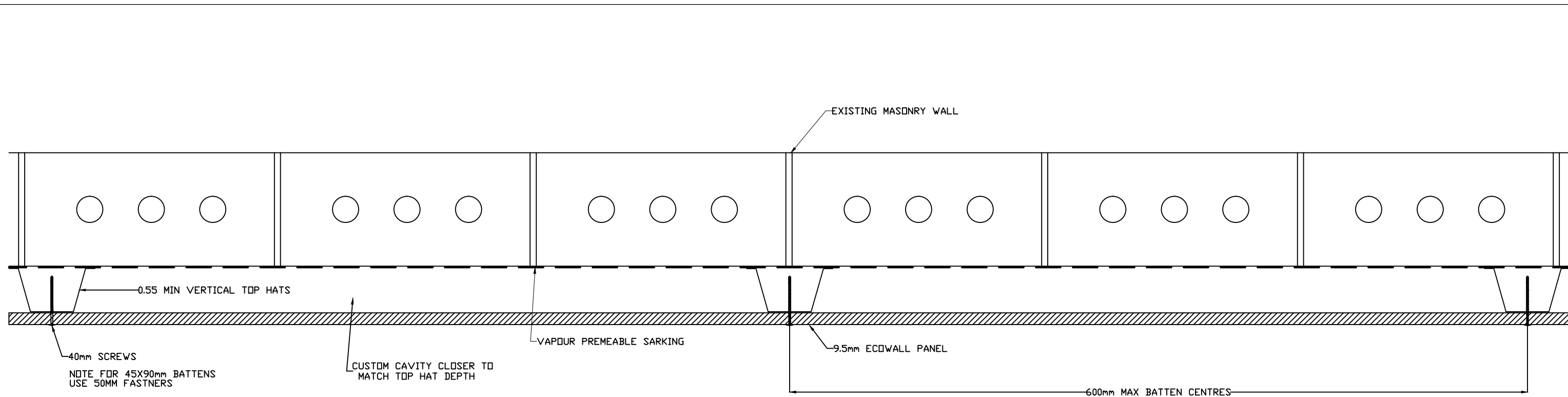

CLADDING OVER MASONRY WITH METAL TOPHATS DETAIL

NOTE: VERTICAL BATTENS ONLY

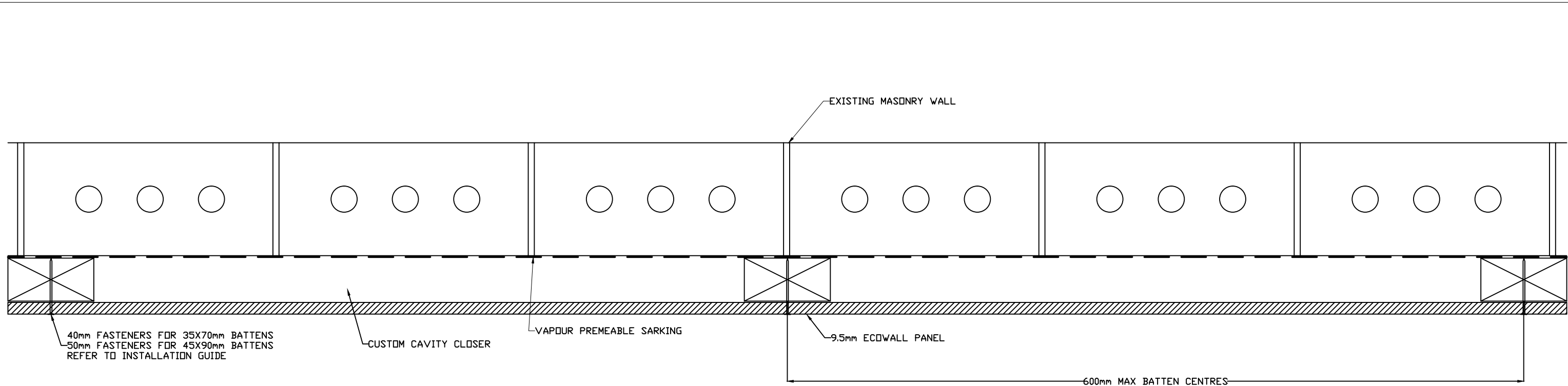

CLADDING OVER BRICK WITH TIMBER BATTEN DETAIL

NOTE: VERTICAL BATTENS ONLY