

WEATHERTEX CONSTRUCTION DETAIL GUIDE

PRIMELOK WEATHERBOARDS

9.5mm CAVITY CONSTRUCTION

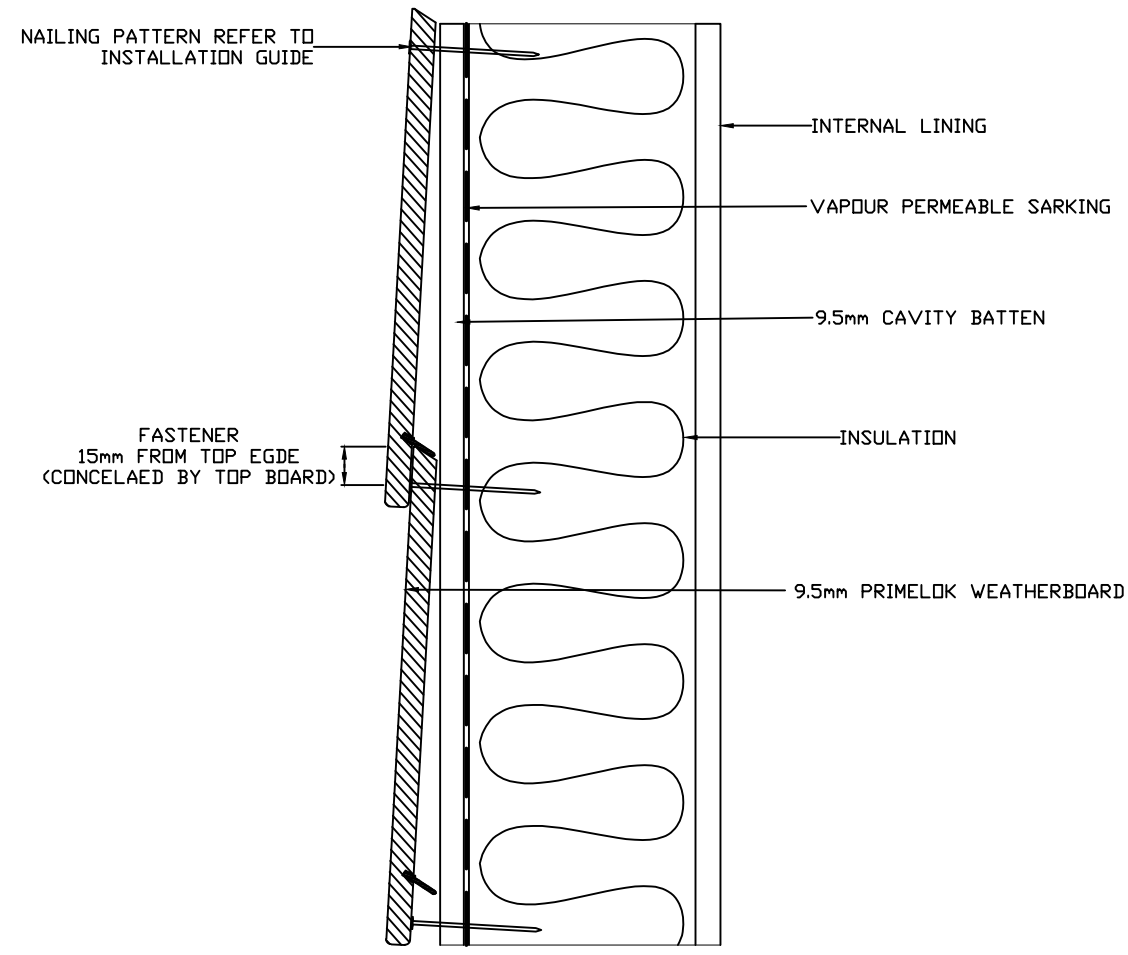



PRIMELOK FIXING
DETAIL

	DRAWING NAME: 9.5mm CAVITY INSTALLATION - PRIMELOK	SCALE: NTS	DRAWN BY: A.MOATE	CHECKED BY: C.O'NEILL	DATE: 26.10.17	DRAWING SET No.: CD-PL-C	SHT SIZE A3
--	---	---------------	----------------------	--------------------------	-------------------	-----------------------------	----------------

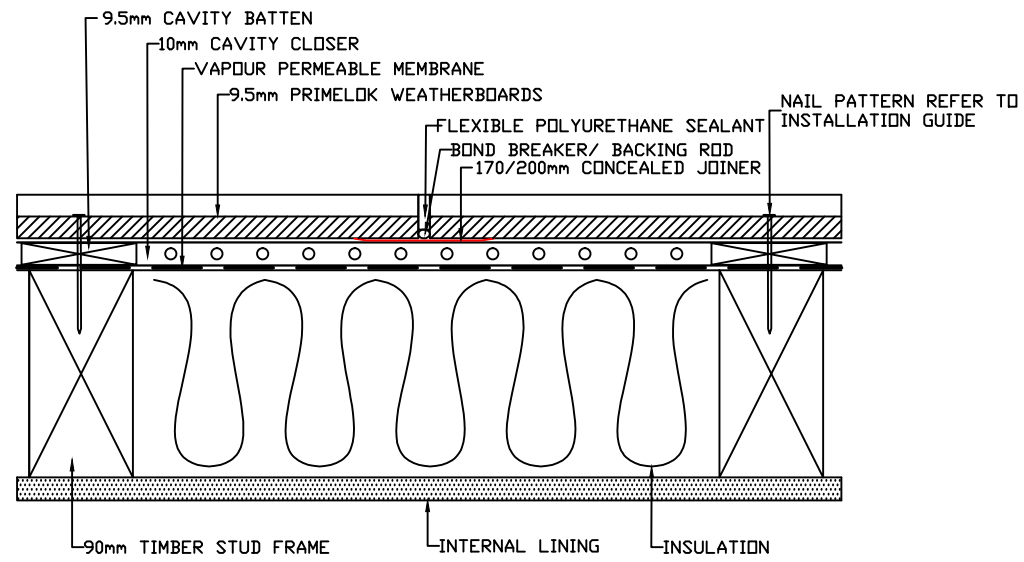

OFF STUD CONCEALED JOINER DETAIL

NOTE: JOINER PROVIDE 6MM GAP

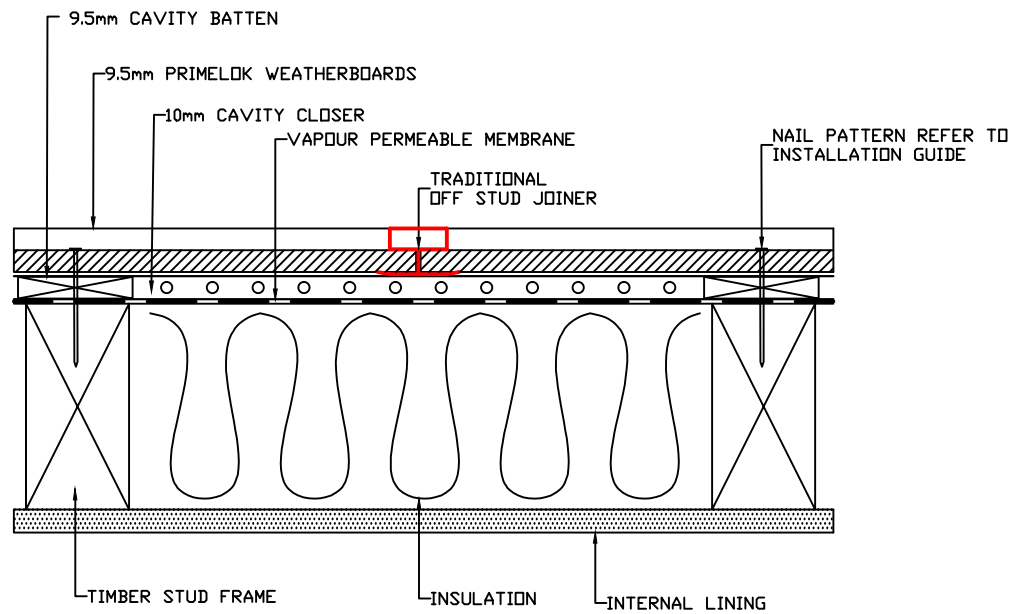

OFF STUD TRADITIONAL JOINER DETAIL



DRAWING NAME:

9.5mm CAVITY INSTALLATION - PRIMELOK

SCALE:

NTS

DRAWN BY:

A.MOATE

CHECKED BY:

C.O'NEILL

DATE:

26.10.17

DRAWING SET No.:

CD-PL-C

SHT SIZE

A3

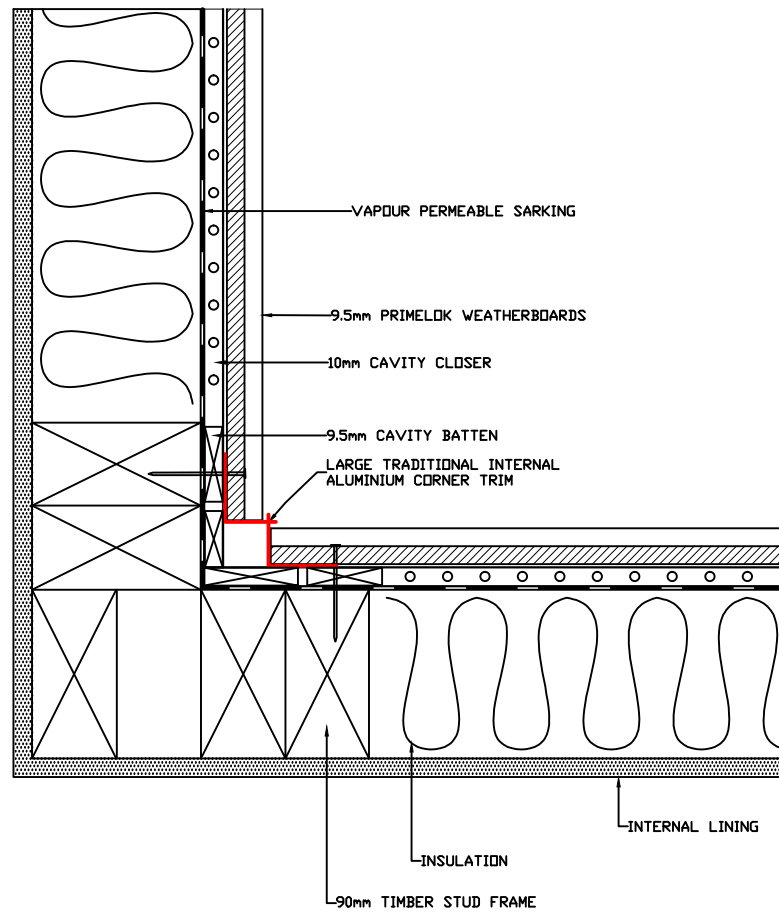

LARGE TRADITIONAL INTERNAL "W" CORNER DETAIL

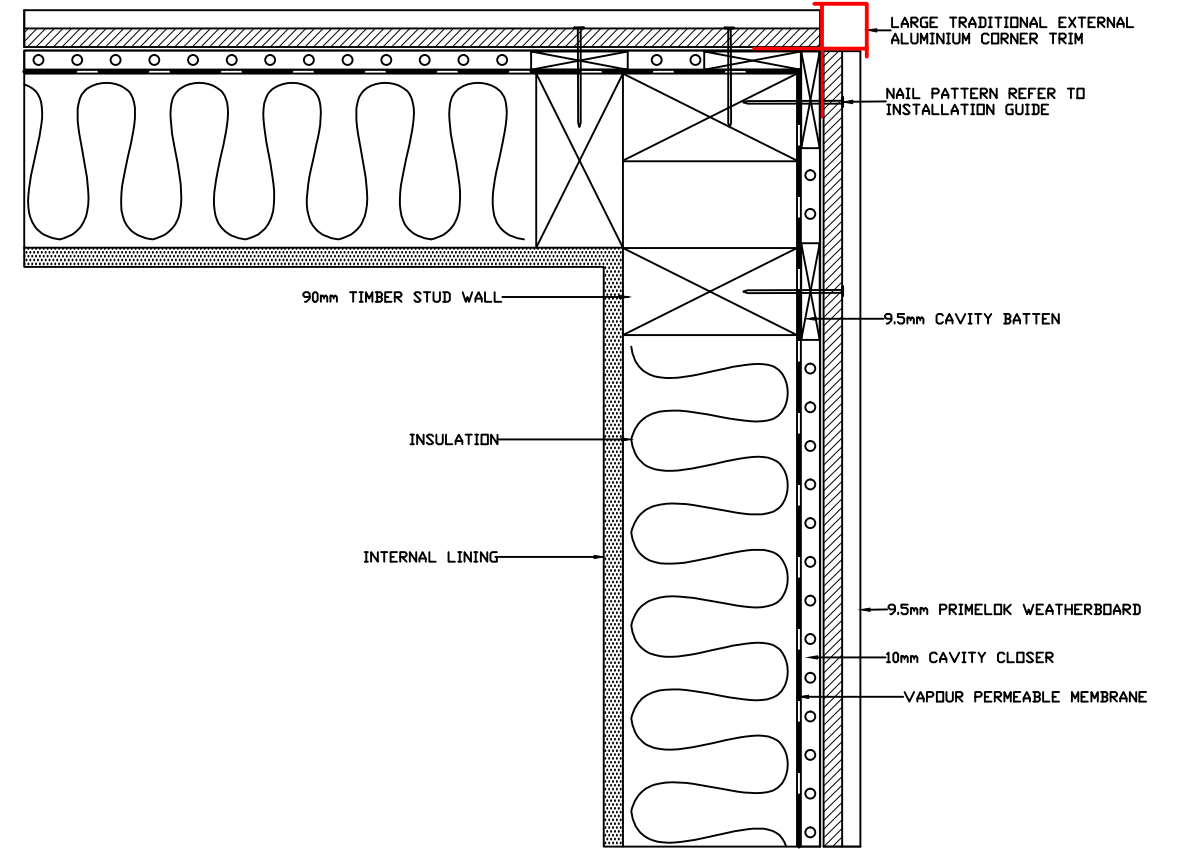

LARGE TRADITIONAL EXTERNAL "BOX" CORNER DETAIL

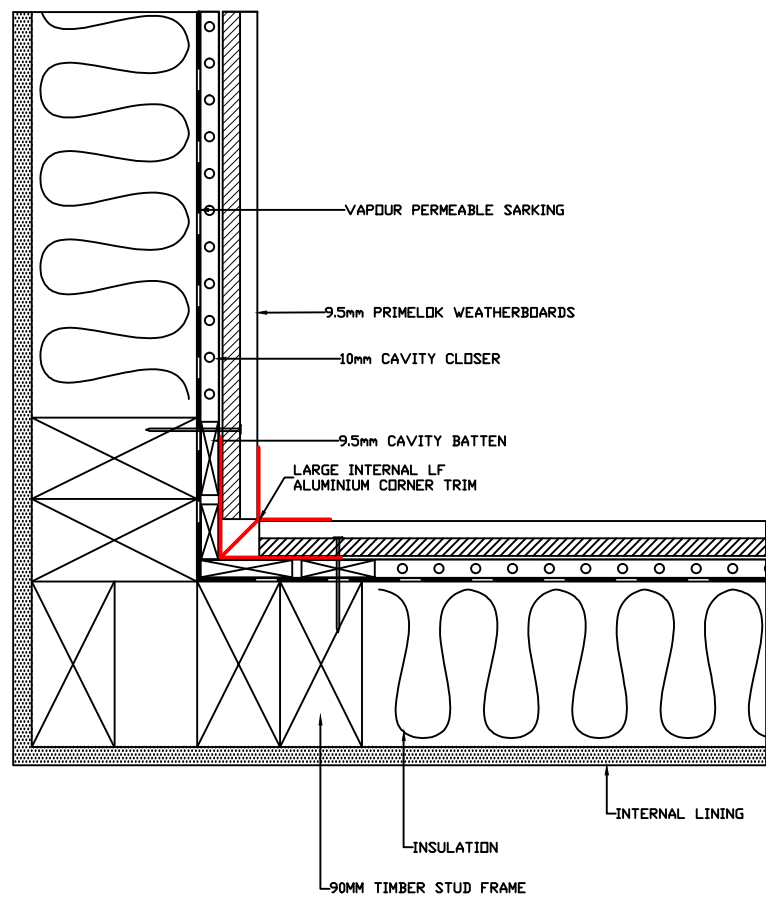

LARGE INTERNAL LF CORNER DETAIL

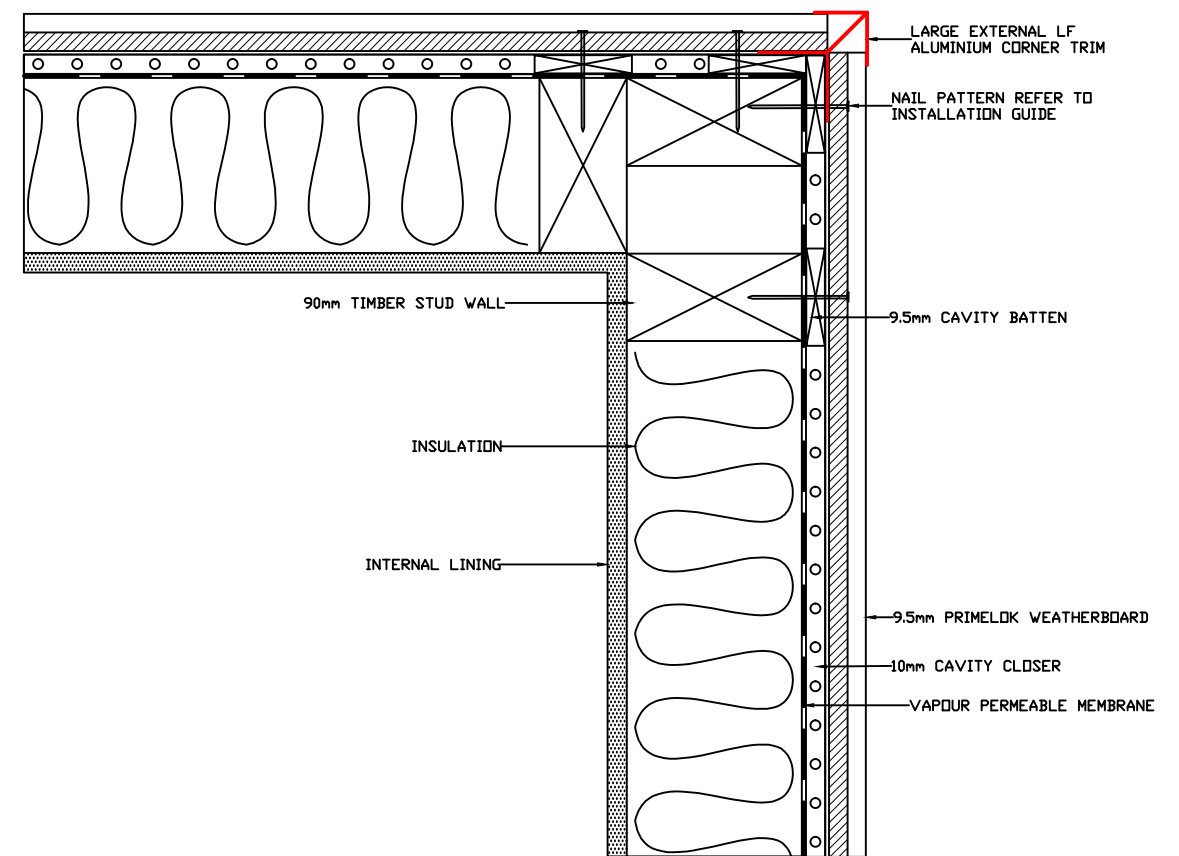

LARGE EXTERNAL LF CORNER DETAIL



DRAWING NAME:
9.5mm CAVITY INSTALLATION - PRIMELOK

SCALE:
NTS

DRAWN BY:
A.MOATE

CHECKED BY:
C.O'NEILL

DATE:
26.10.17

DRAWING SET No.:
CD-PL-C

SHT SIZE
A3

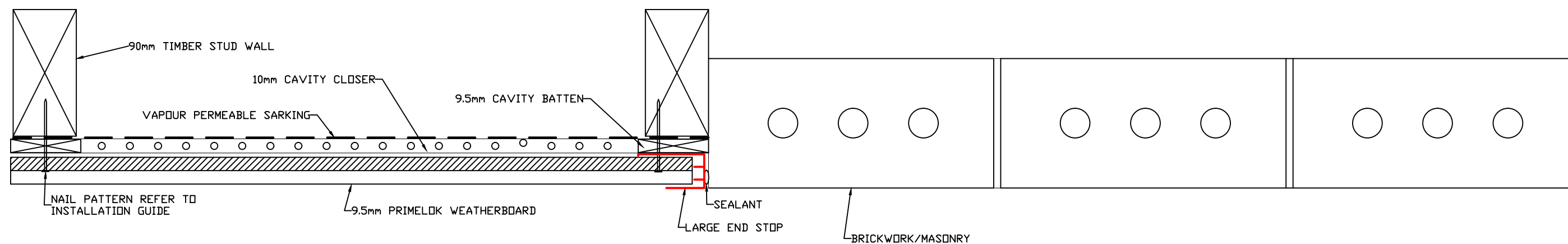

ENDSTOP TO MASONRY DETAIL



DRAWING NAME:	SCALE:	DRAWN BY:	CHECKED BY:	DATE:	DRAWING SET No.:	SHT SIZE
9.5mm CAVITY INSTALLATION - PRIMELOK	NTS	A.MOATE	C.O'NEILL	26.10.17	CD-PL-C	A3

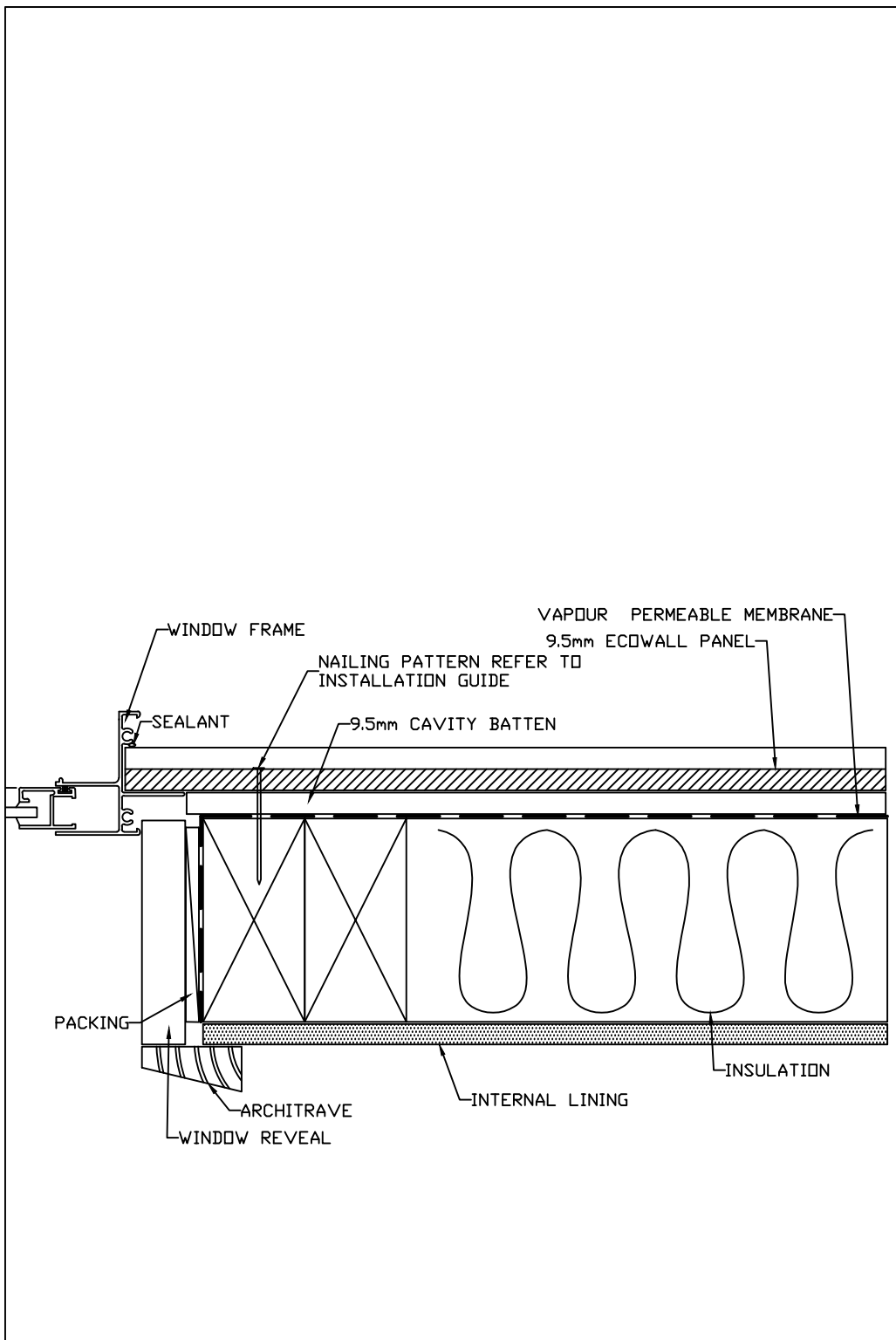

WINDOW JAMB DETAIL

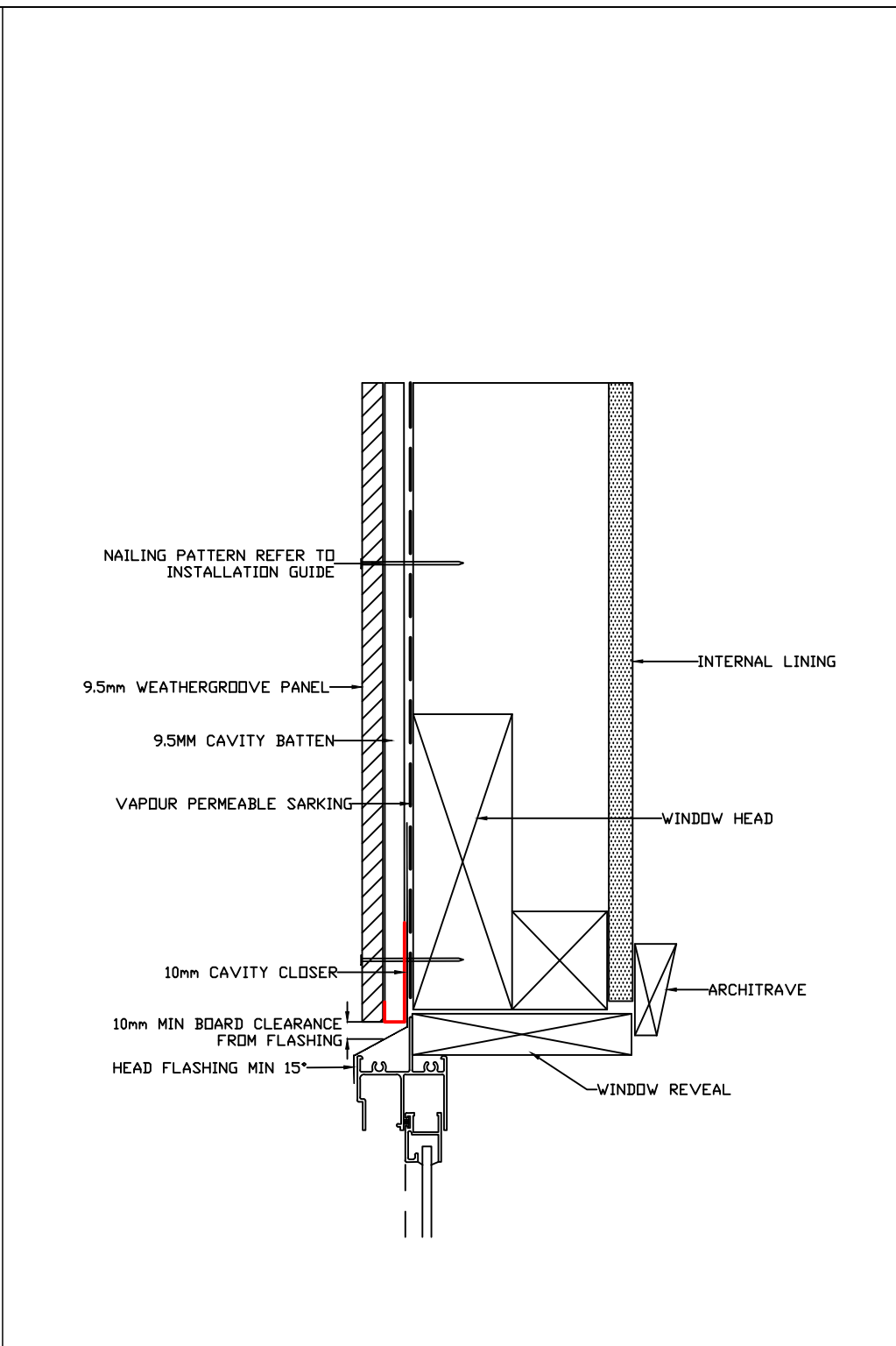

WINDOW HEAD DETAIL

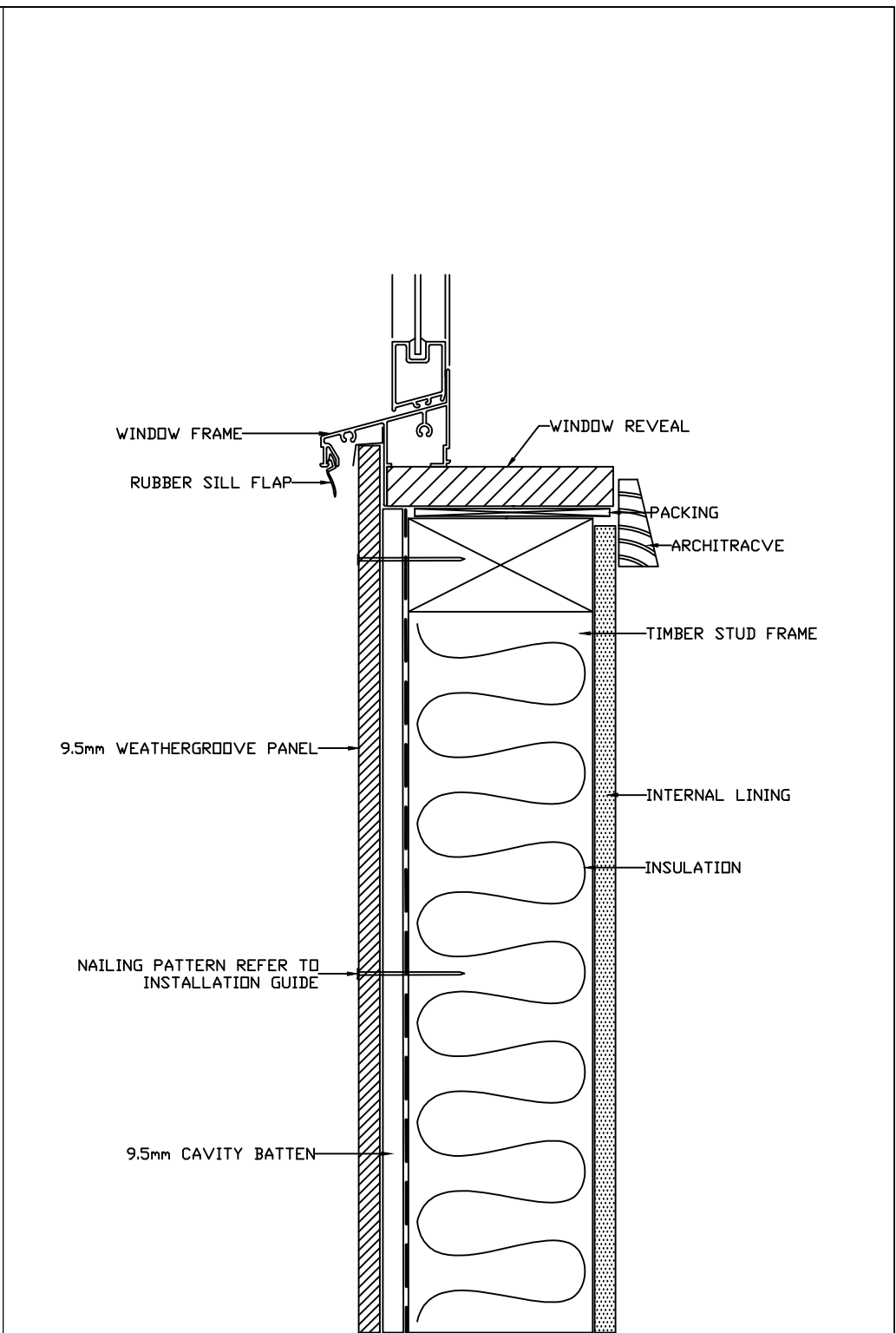

WINDOW SILL DETAIL

	DRAWING NAME:	SCALE:	DRAWN BY:	CHECKED BY:	DATE:	DRAWING SET No.:	SHT SIZE
	9.5mm CAVITY INSTALLATION - PRIMELOK	NTS	A.MOATE	C.O'NEILL	26.10.17	CD-PL-C	A3

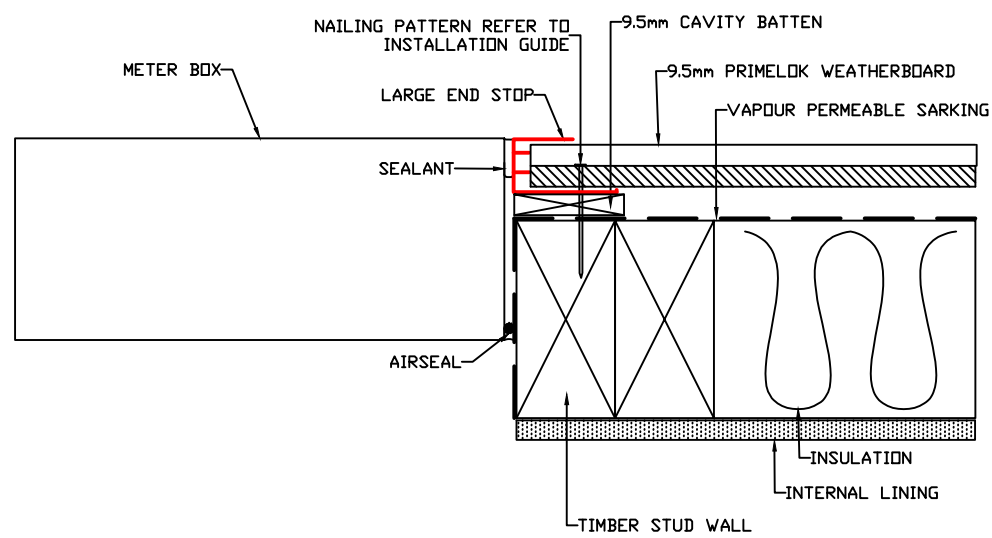

METER BOX JAMB
DETAIL

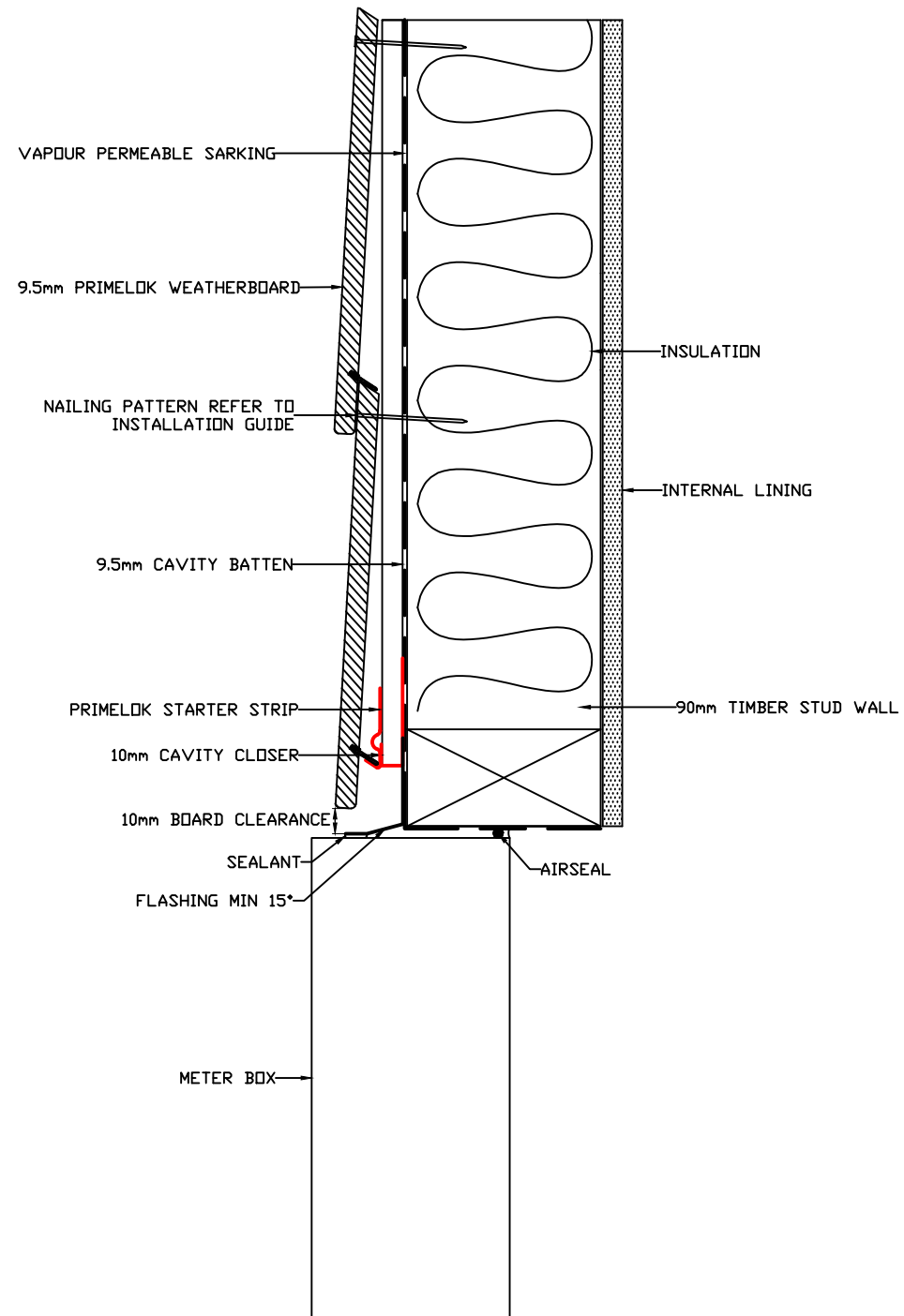

METER BOX HEAD
DETAIL

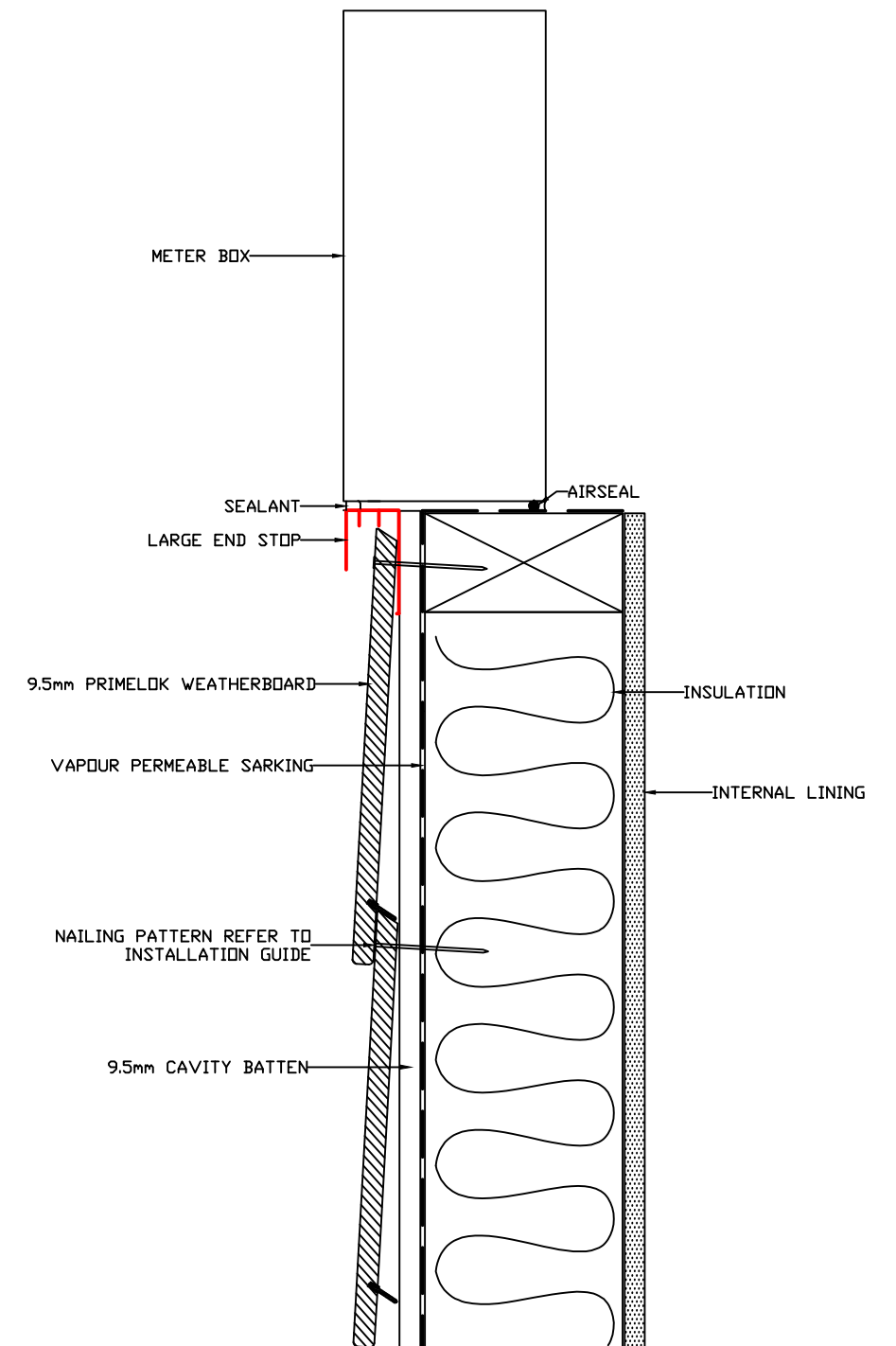

METER BOX SILL
DETAIL

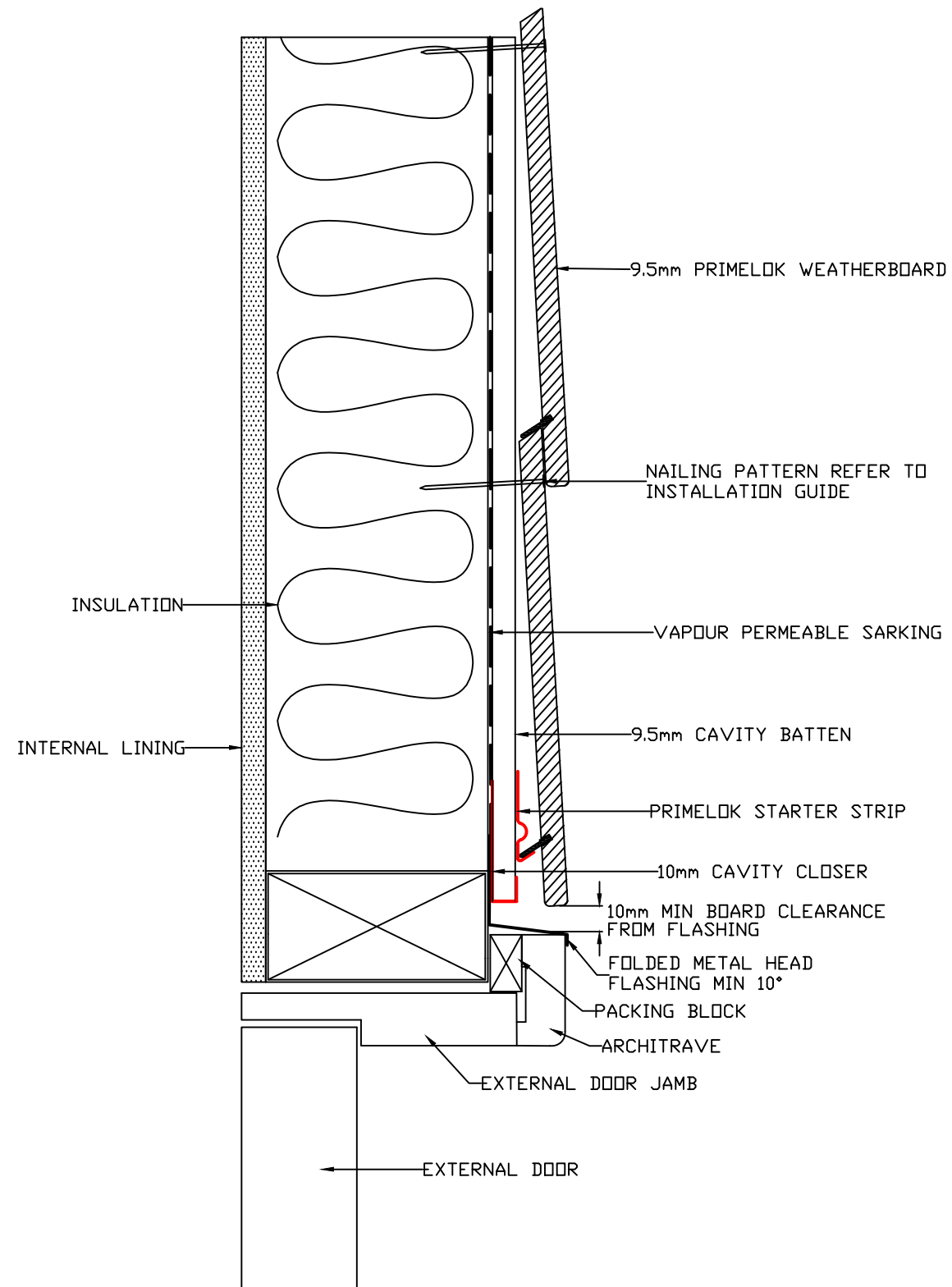

DOOR HEAD DETAIL

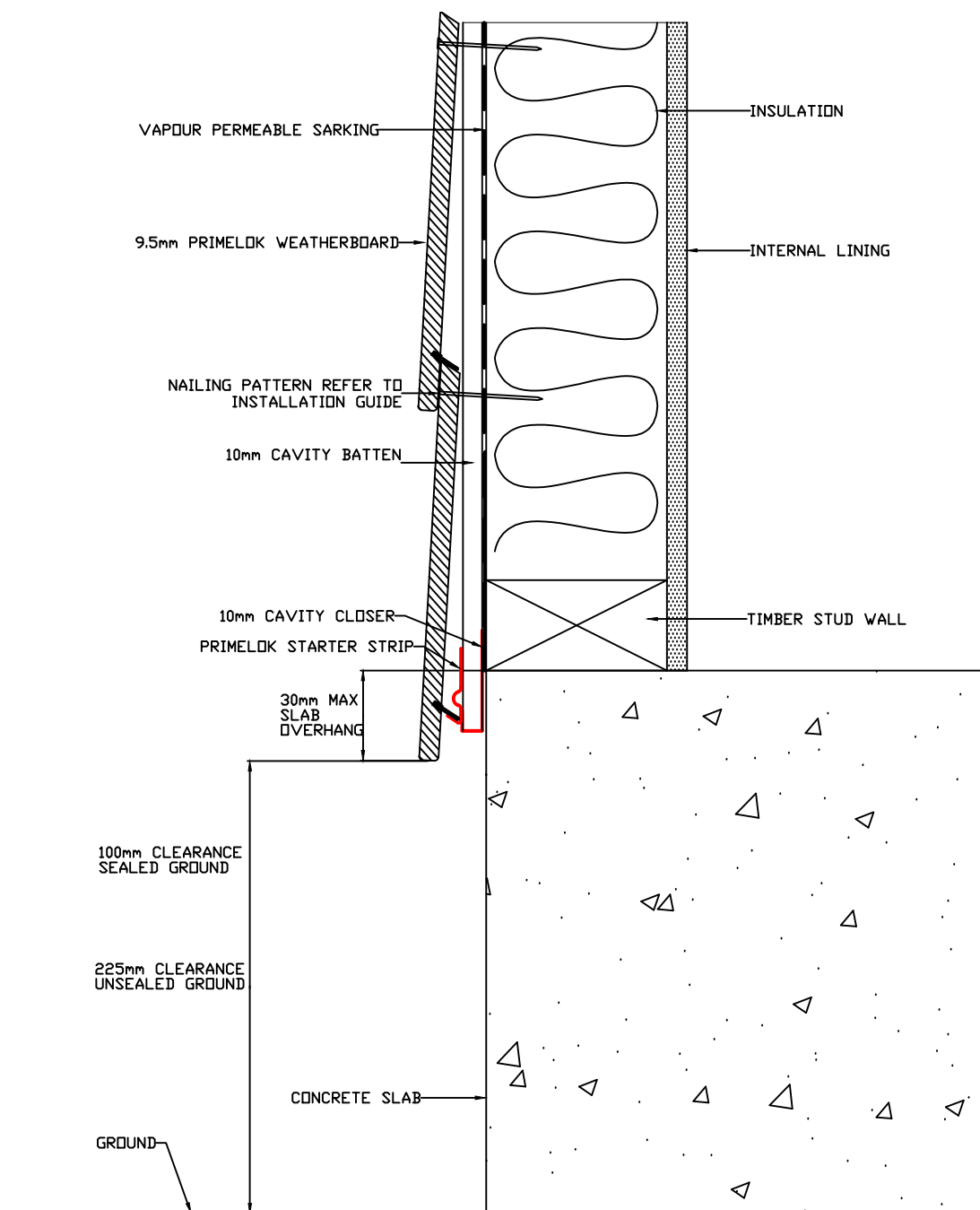

CONCRETE SLAB
GROUND CLEARANCE DETAIL

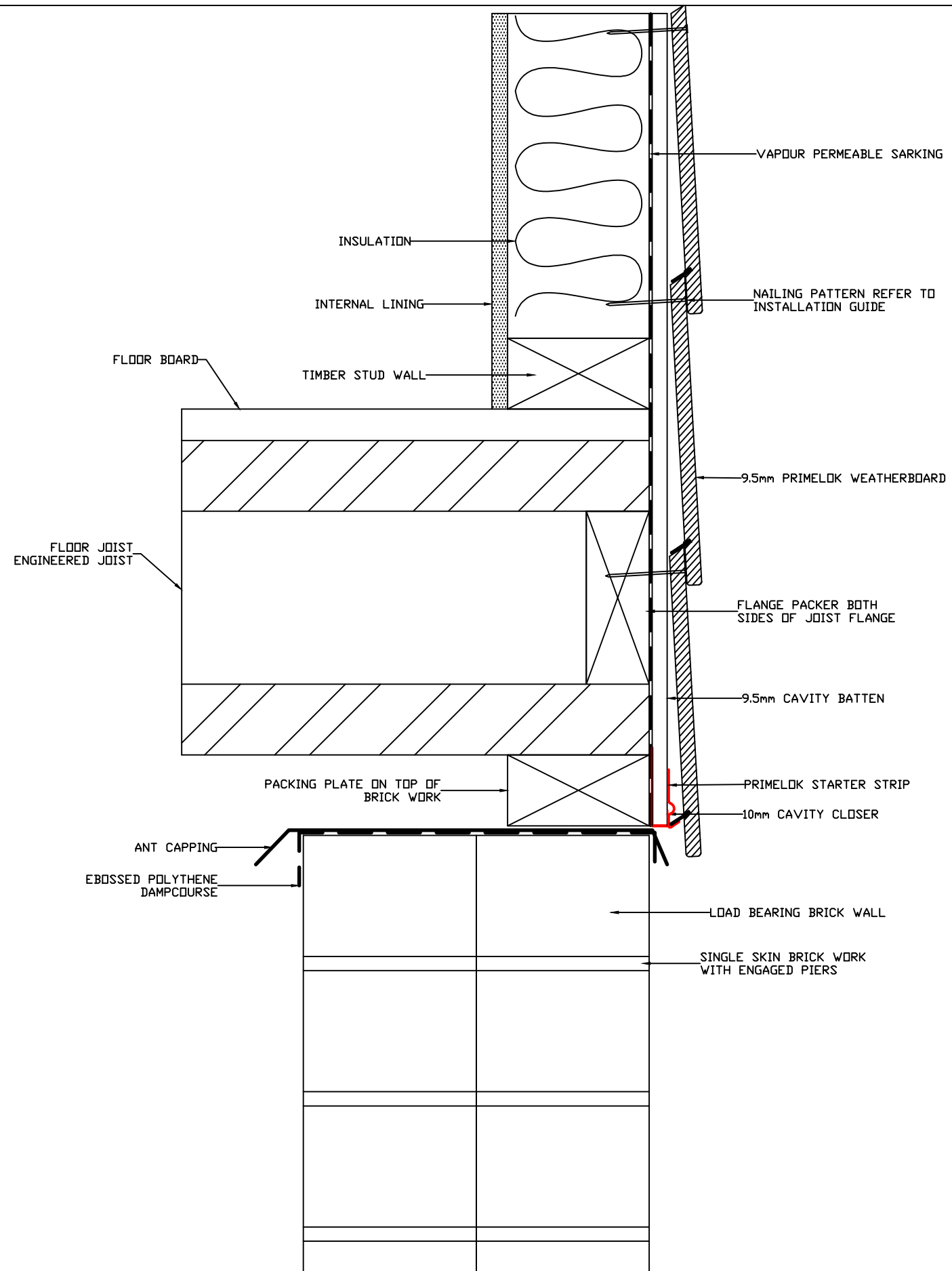

OVER DOUBLE BRICK PIER DETAIL



DRAWING NAME:
9.5mm CAVITY INSTALLATION - PRIMELOK

SCALE:
NTS

DRAWN BY:
A.MOATE

CHECKED BY:
C.O'NEILL

DATE:
26.10.17

DRAWING SET No.:
CD-PL-C

SHT SIZE
A3

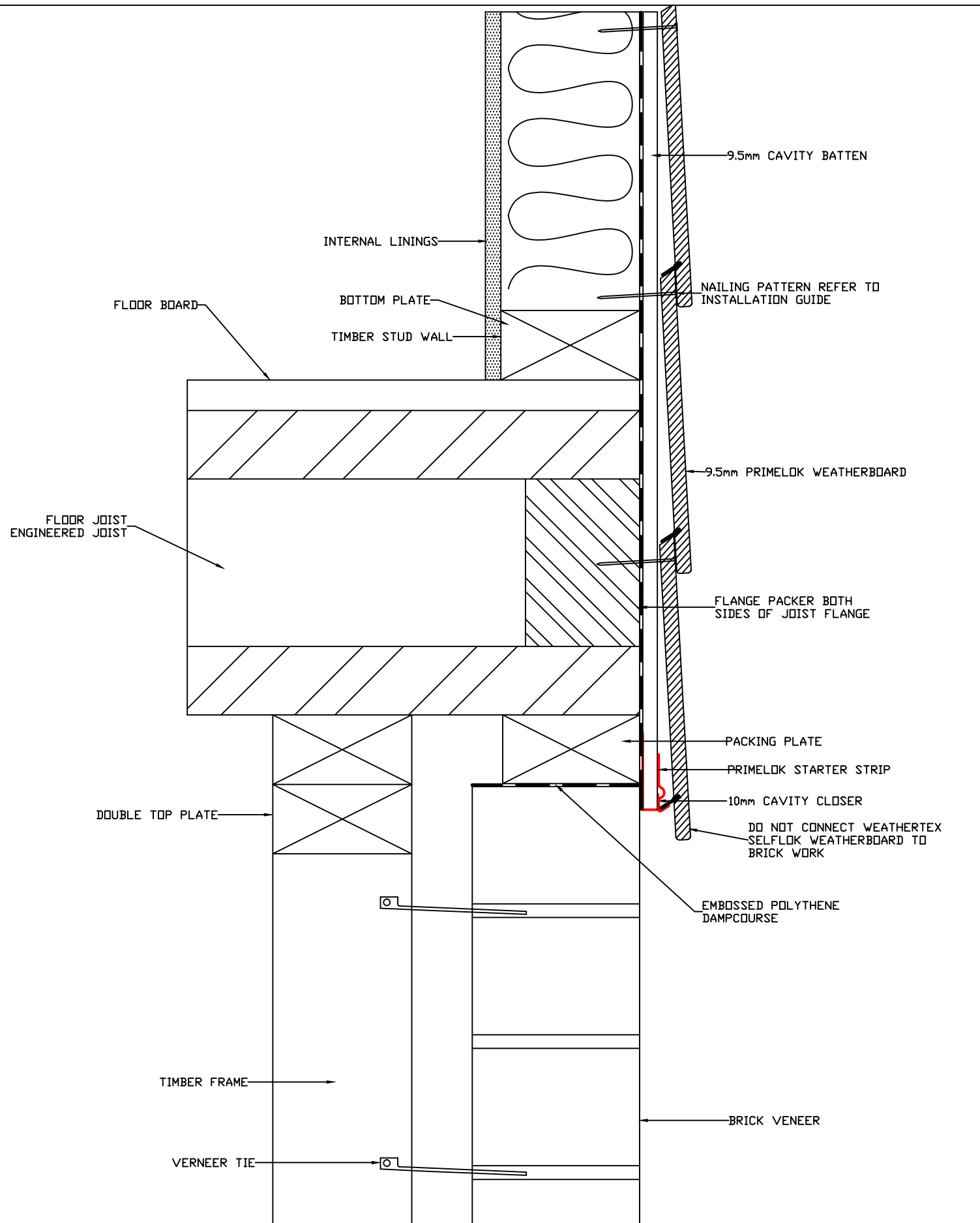

FLUSH WITH BRICK VENEER DETAIL

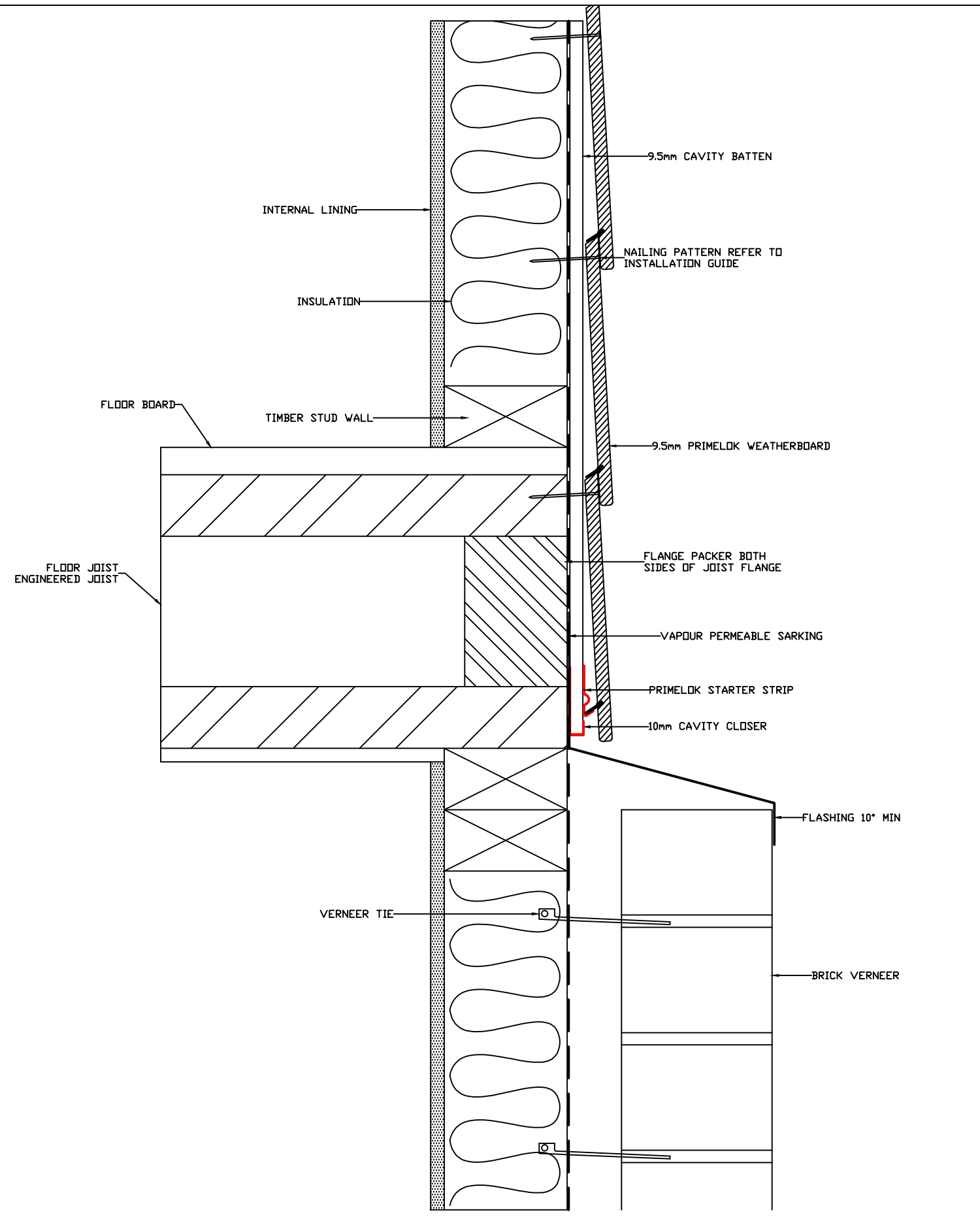

SET BACK OVER BRICK VENEER DETAIL



DRAWING NAME:
9.5mm CAVITY INSTALLATION - PRIMELOK

SCALE:
NTS

DRAWN BY:
A.MOATE

CHECKED BY:
C.O'NEILL

DATE:
26.10.17

DRAWING SET No.:
CD-PL-C

SHT SIZE
A3

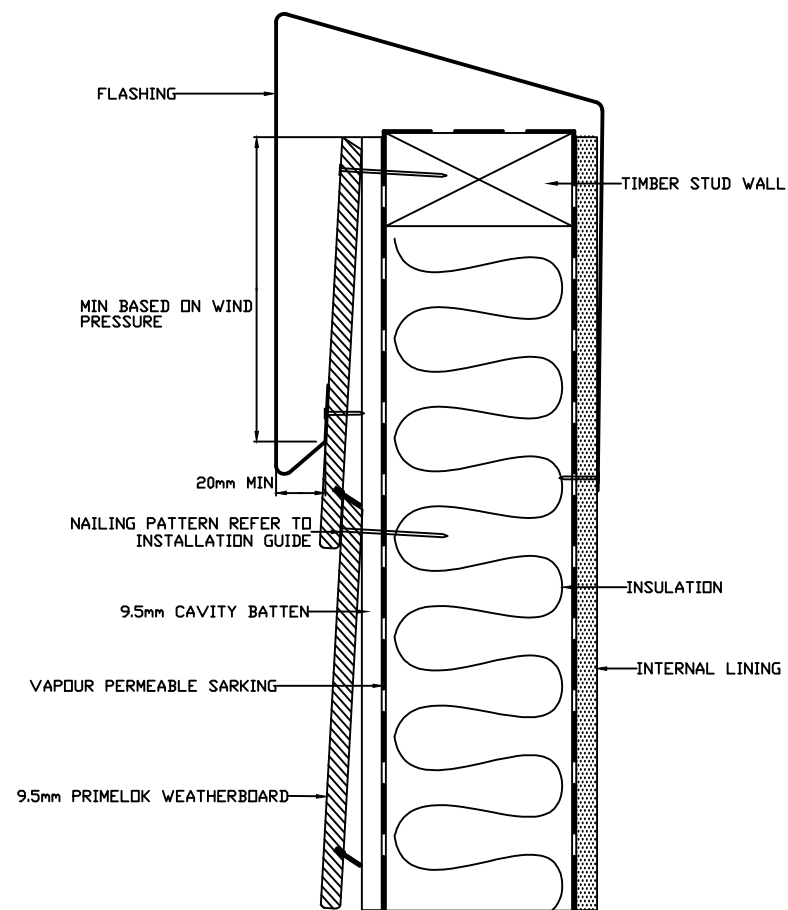

PARAPET DETAIL

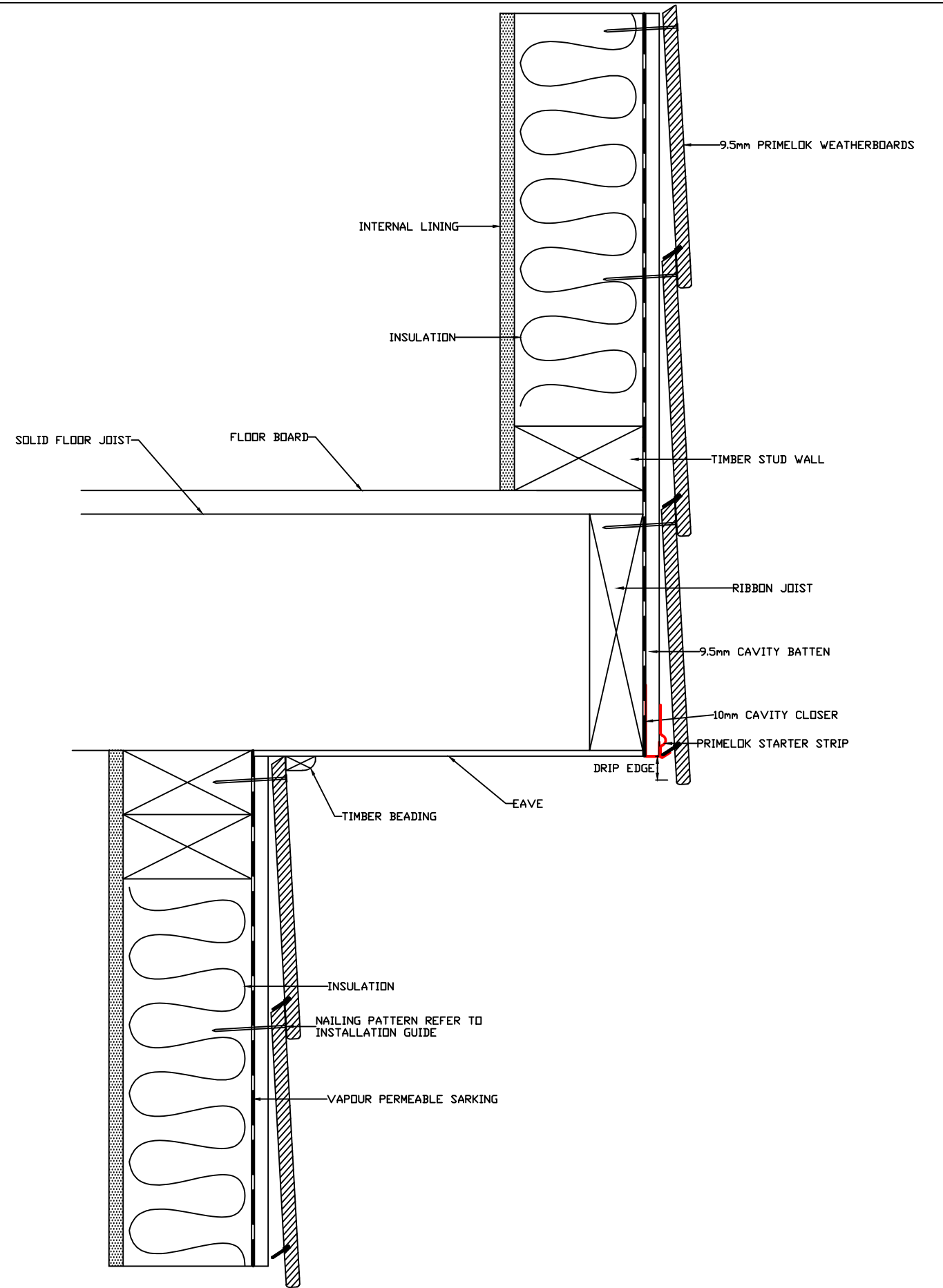

CANTILEVER ROOF DETAIL



DRAWING NAME:
9.5mm CAVITY INSTALLATION - PRIMELOK

SCALE:
NTS

DRAWN BY:
A.MOATE

CHECKED BY:
C.O'NEILL

DATE:
26.10.17

DRAWING SET No.:
CD-PL-C

SHT SIZE
A3

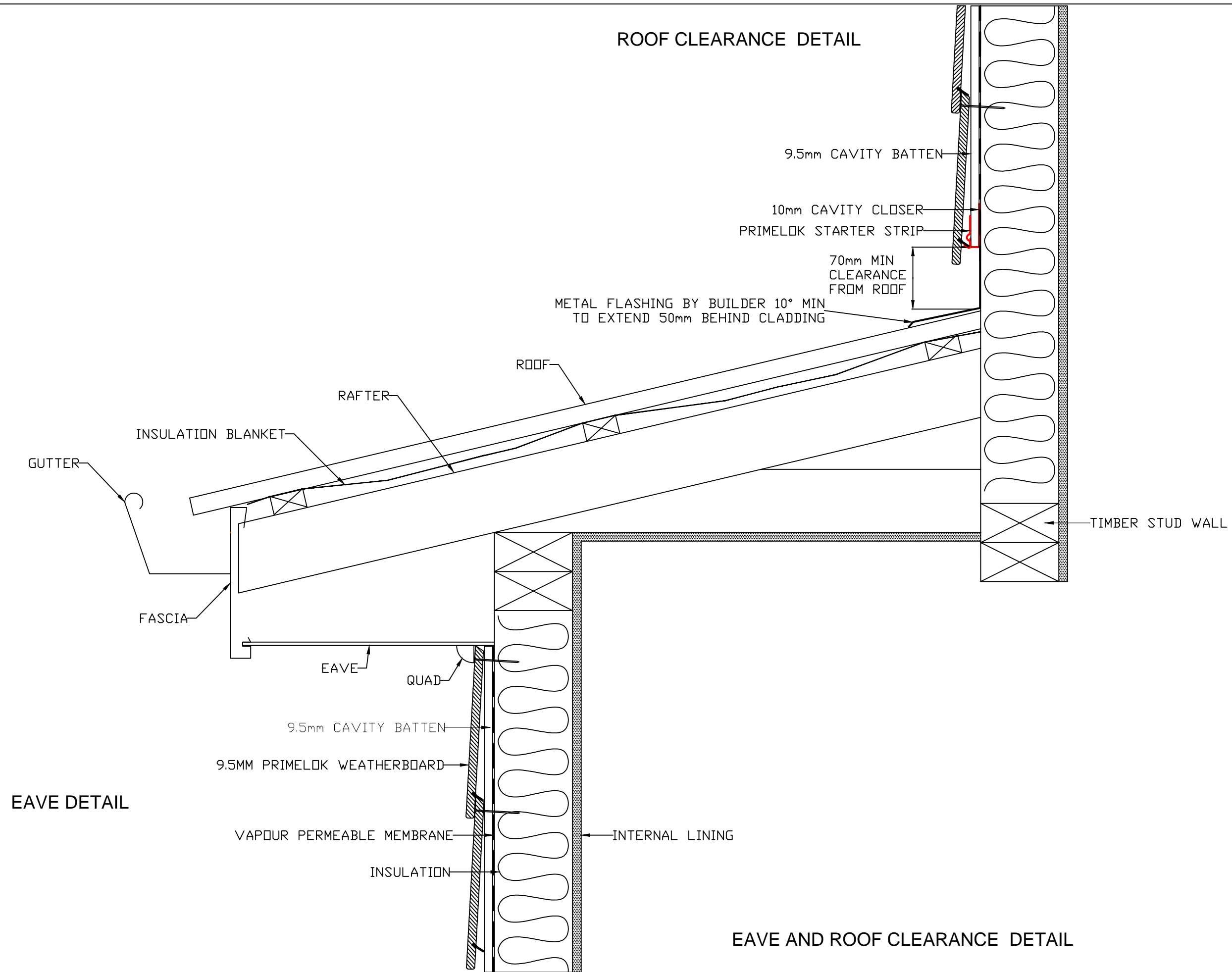

ROOF CLEARANCE DETAIL

EAVE DETAIL

EAVE AND ROOF CLEARANCE DETAIL

	DRAWING NAME:	SCALE:	DRAWN BY:	CHECKED BY:	DATE:	DRAWING SET No.:	SHT SIZE
	9.5mm CAVITY INSTALLATION - PRIMELOK	NTS	A.MOATE	C.O'NEILL	26.10.17	CD-PL-C	A3

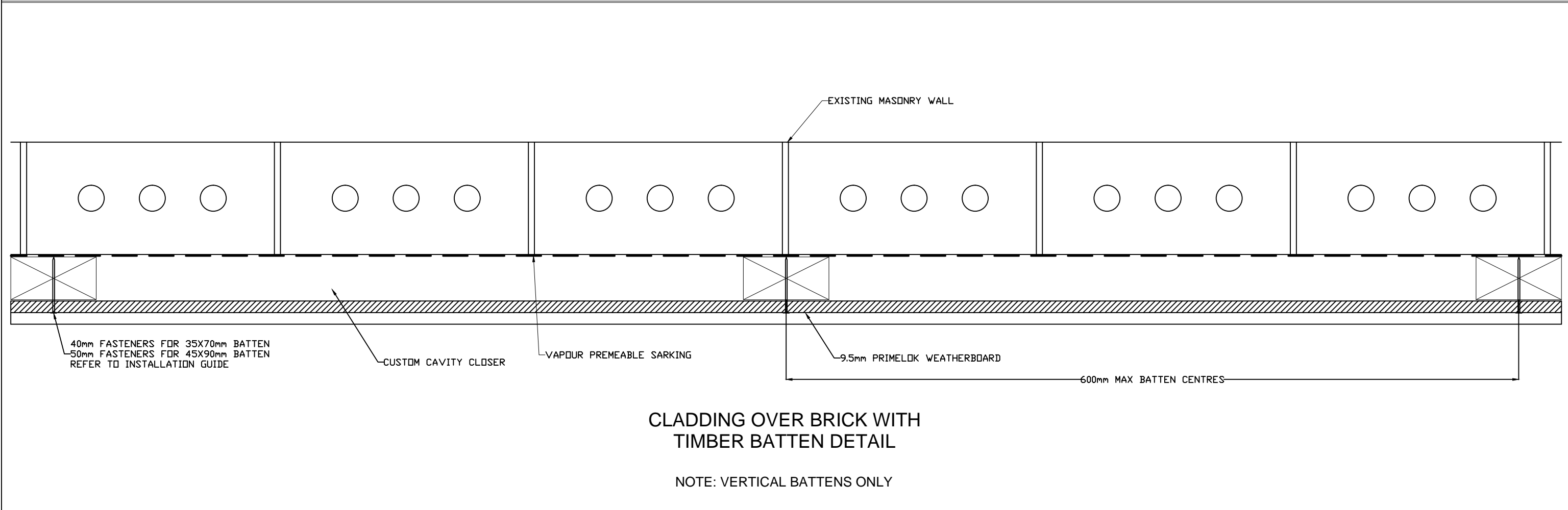
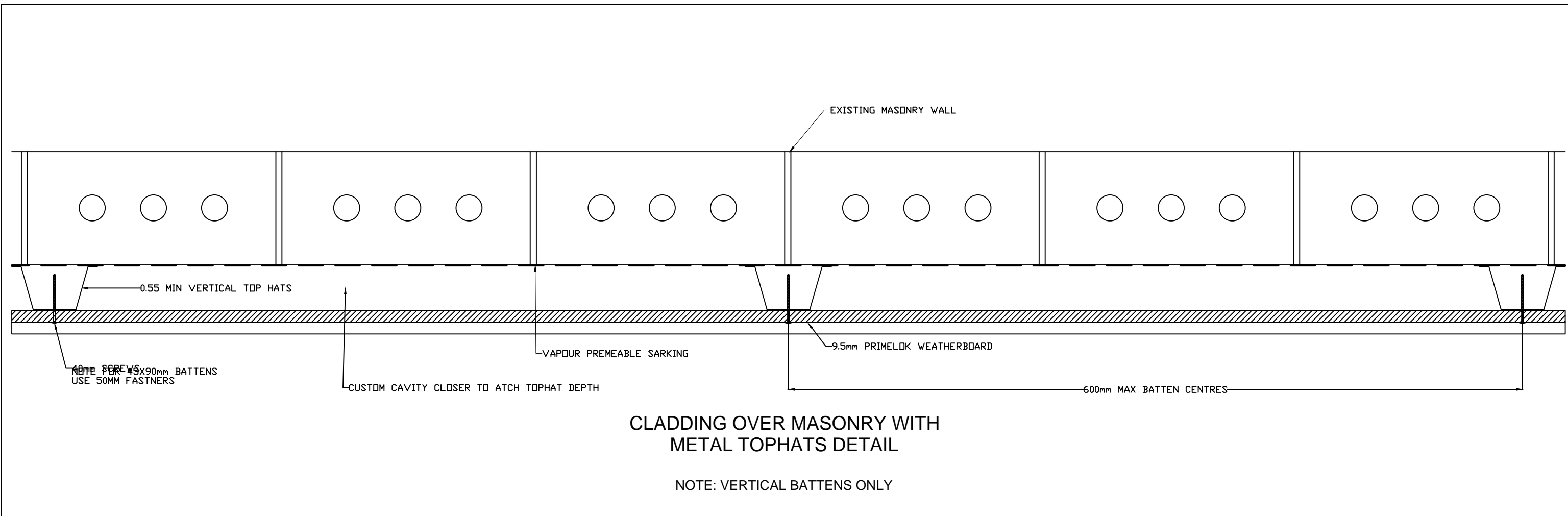

	DRAWING NAME:	SCALE:	DRAWN BY:	CHECKED BY:	DATE:	DRAWING SET No.:	SHT SIZE
	9.5mm CAVITY INSTALLATION - PRIMELOK	NTS	A.MOATE	C.O'NEILL	26.10.17	CD-PL-C	A3