

# WEATHERTEX CONSTRUCTION DETAIL GUIDE

## ECOWALL PANELS

### DIRECT FIX

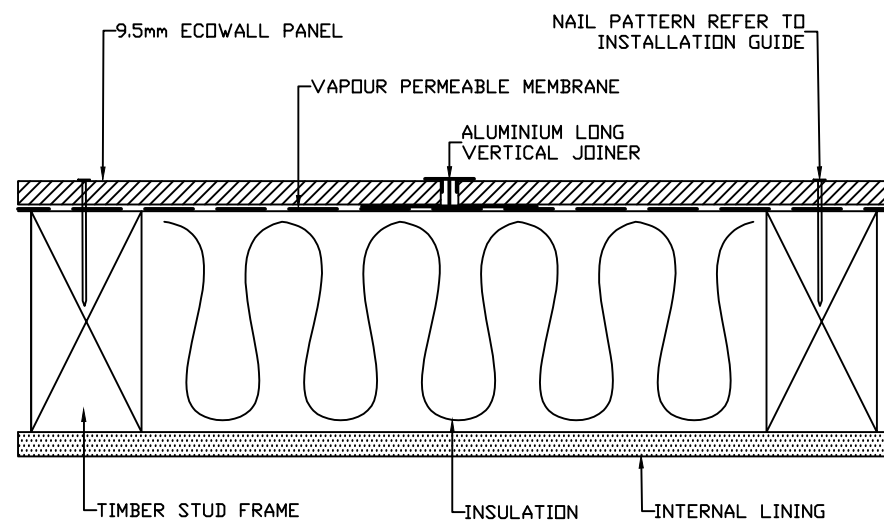



LONG VERTICAL JOINDER DETAIL

NOTE: VERTICAL JOING SUPPORTED BY 600mm CENTRE DWANGS/NOGGINS

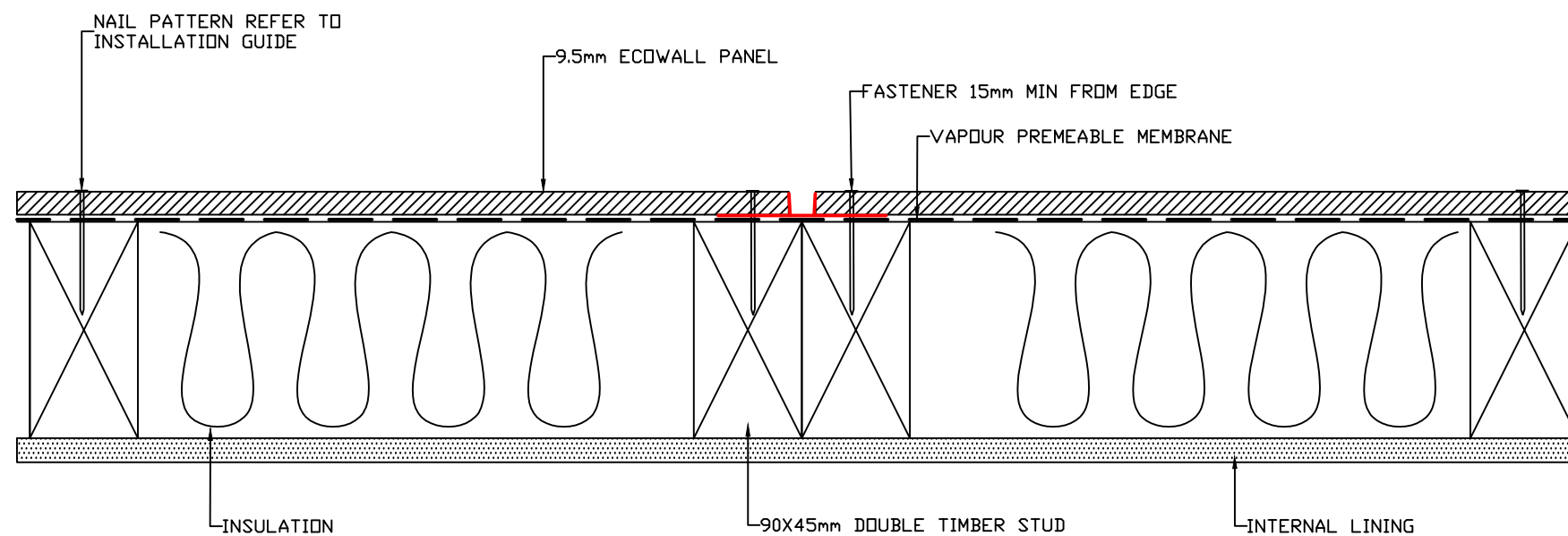

DEEP CHANNEL JOINDER DETAIL



DRAWING NAME:

DIRECT FIX INSTALLATION - ECOWALL

SCALE:

NTS

DRAWN BY:

A.MOATE

CHECKED BY:

C.O'NEILL

DATE:

26.10.17

DRAWING SET No.:

CD-EW-D

SHT SIZE

A3

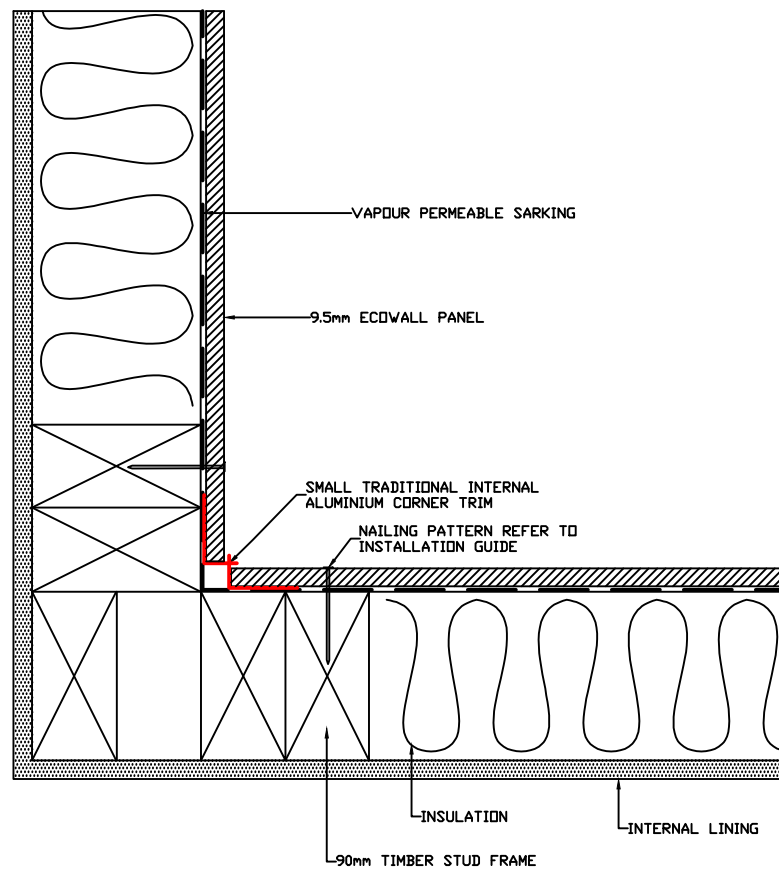

SMALL TRADITIONAL INTERNAL "W" CORNER DETAIL

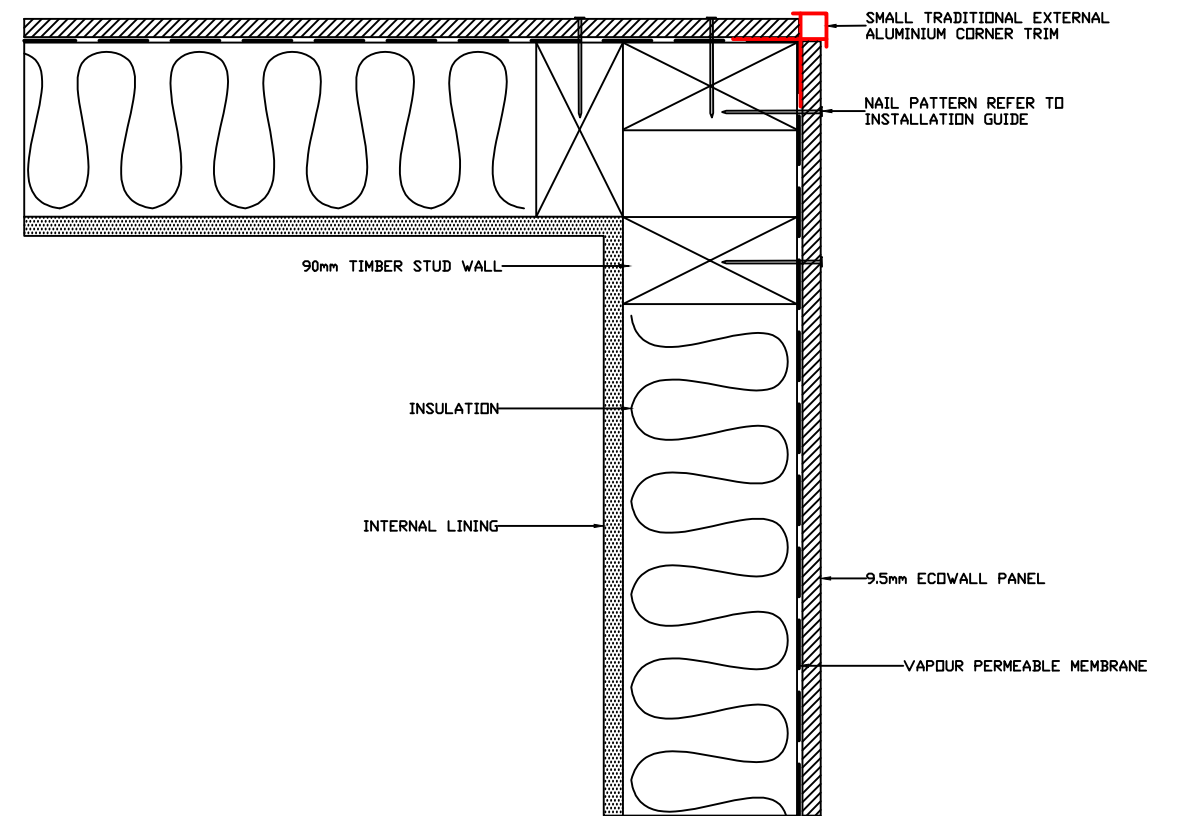

SMALL TRADITIONAL EXTERNAL "BOX" CORNER DETAIL

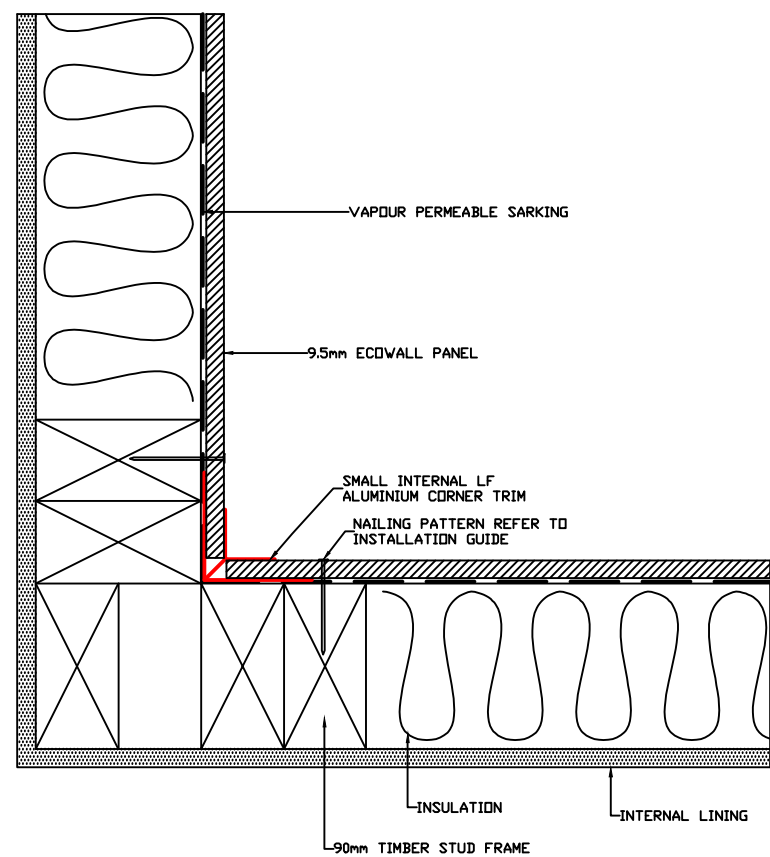

SMALL INTERNAL LF CORNER DETAIL

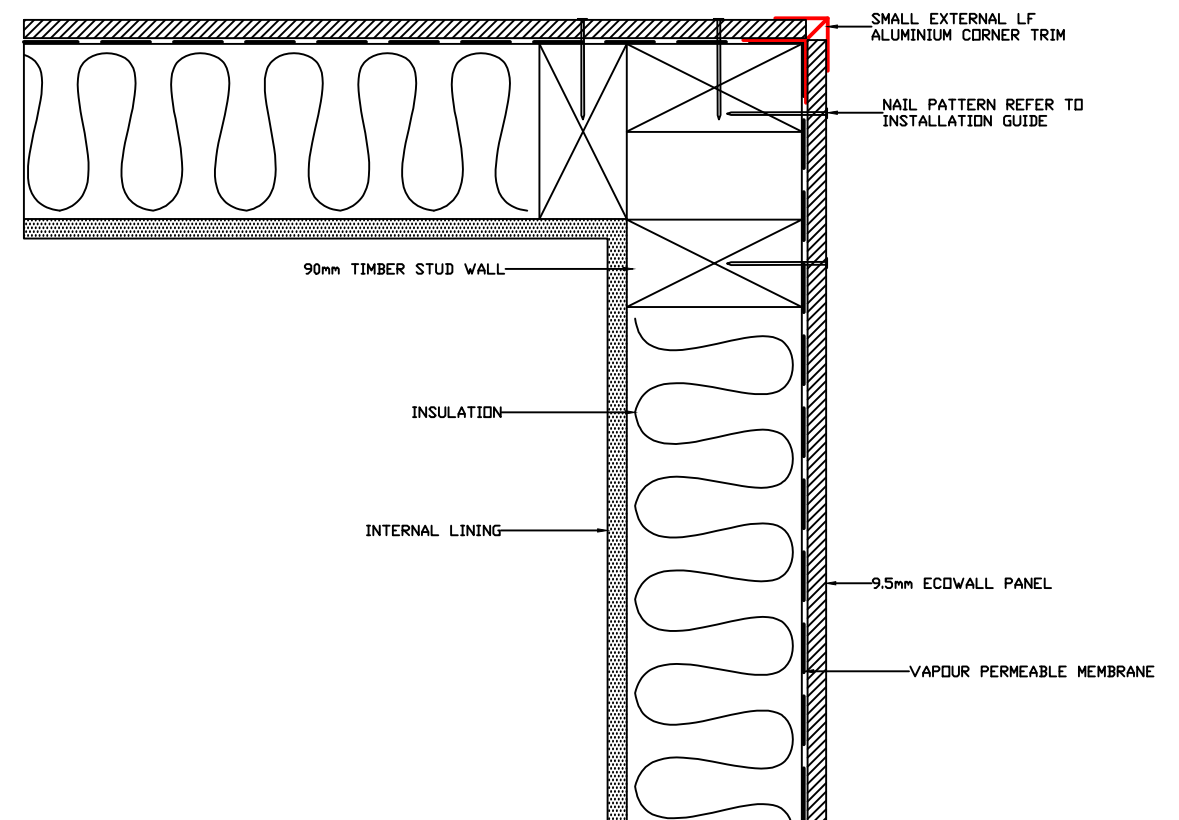

SMALL EXTERNAL LF CORNER DETAIL

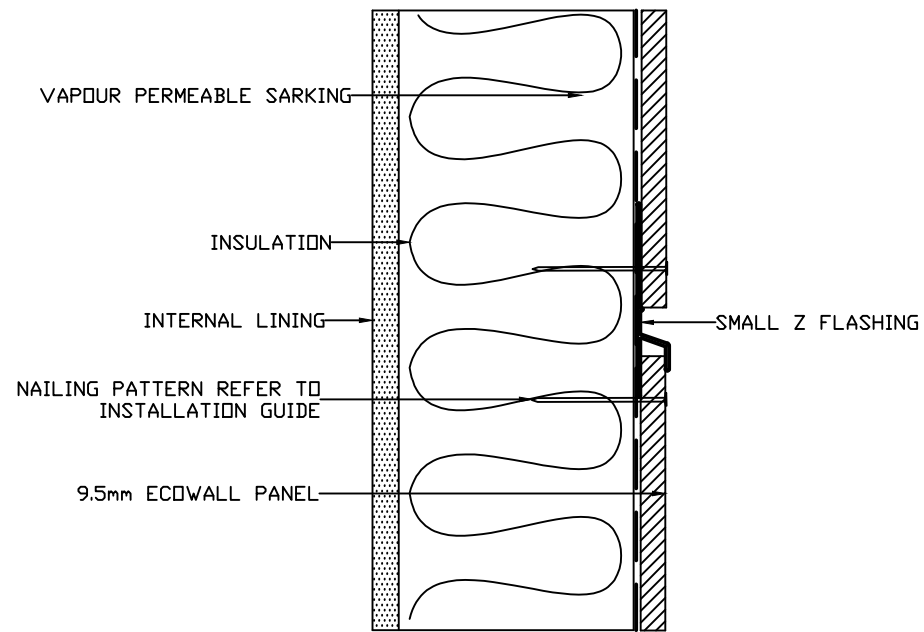

SMALL Z FLASHING JOIN DETAIL

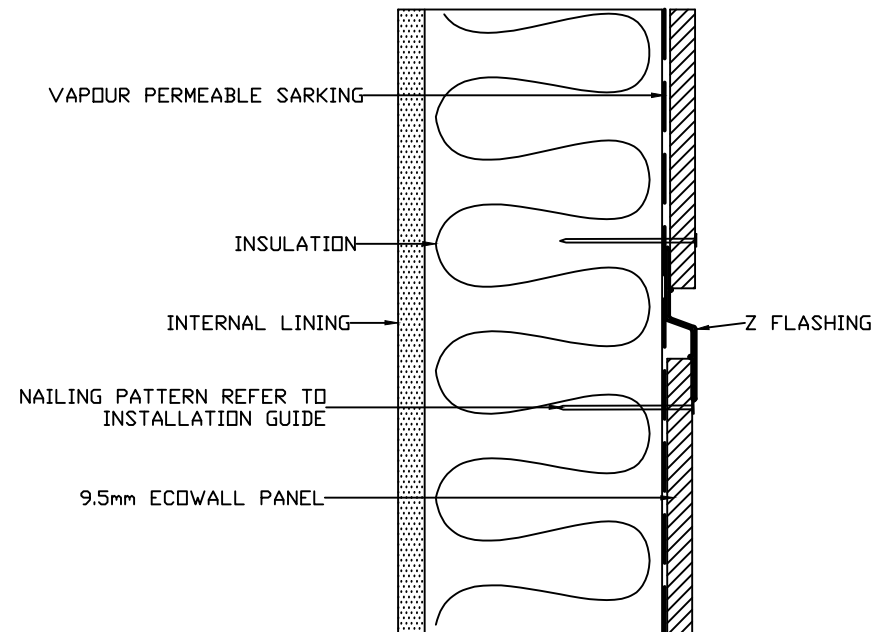

Z FLASHING JOIN DETAIL

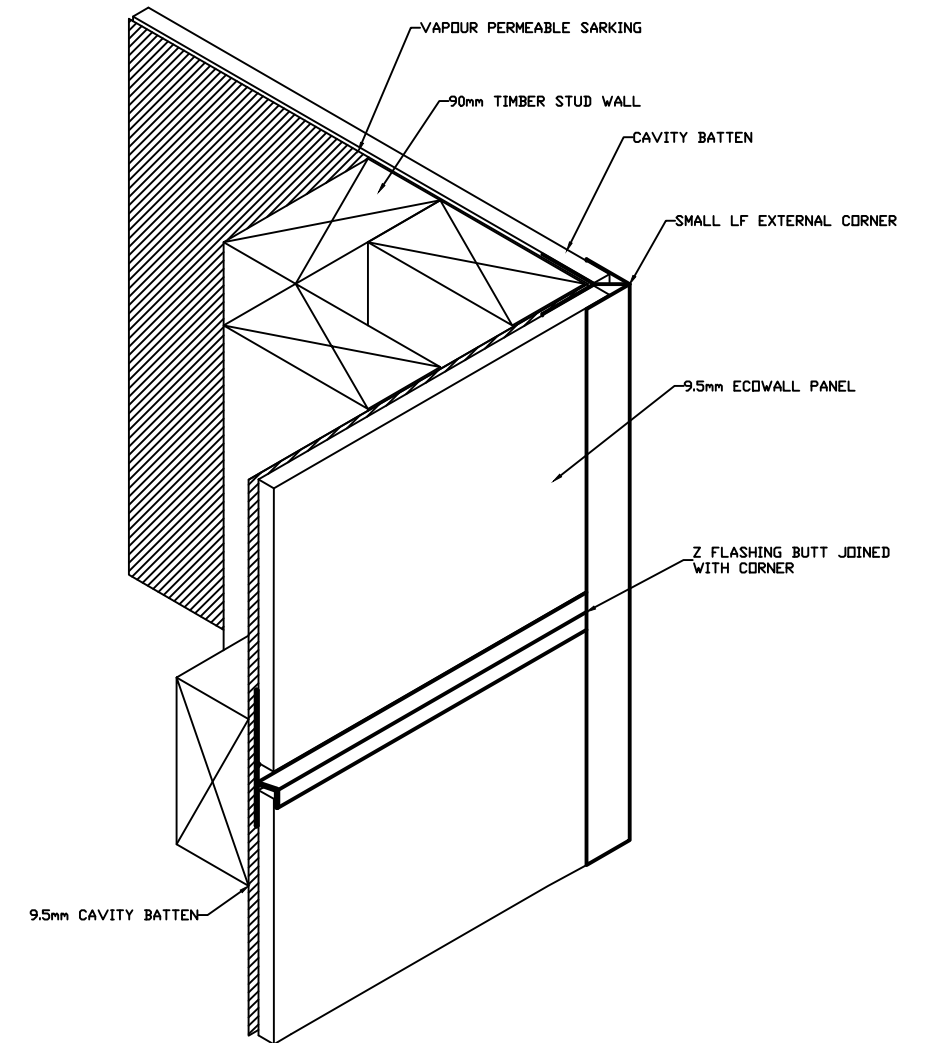

Z FLASHING INTO CORNER DETAIL



DRAWING NAME:  
DIRECT FIX INSTALLATION - ECOWALL

SCALE:  
NTS

DRAWN BY:  
A.MOATE

CHECKED BY:  
C.O'NEILL

DATE:  
26.10.17

DRAWING SET No.:  
CD-EW-D

SHT SIZE  
A3

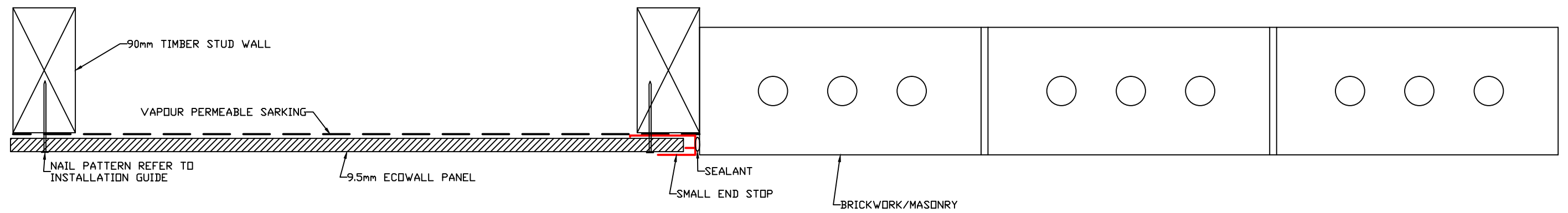

END STOP TO MASONRY BRICK DETAIL



DRAWING NAME:

DIRECT FIX INSTALLATION - ECOWALL

SCALE:

NTS

DRAWN BY:

A.MOATE

CHECKED BY:

C.O'NEILL

DATE:

26.10.17

DRAWING SET No.:

CD-EW-D

SHT SIZE

A3

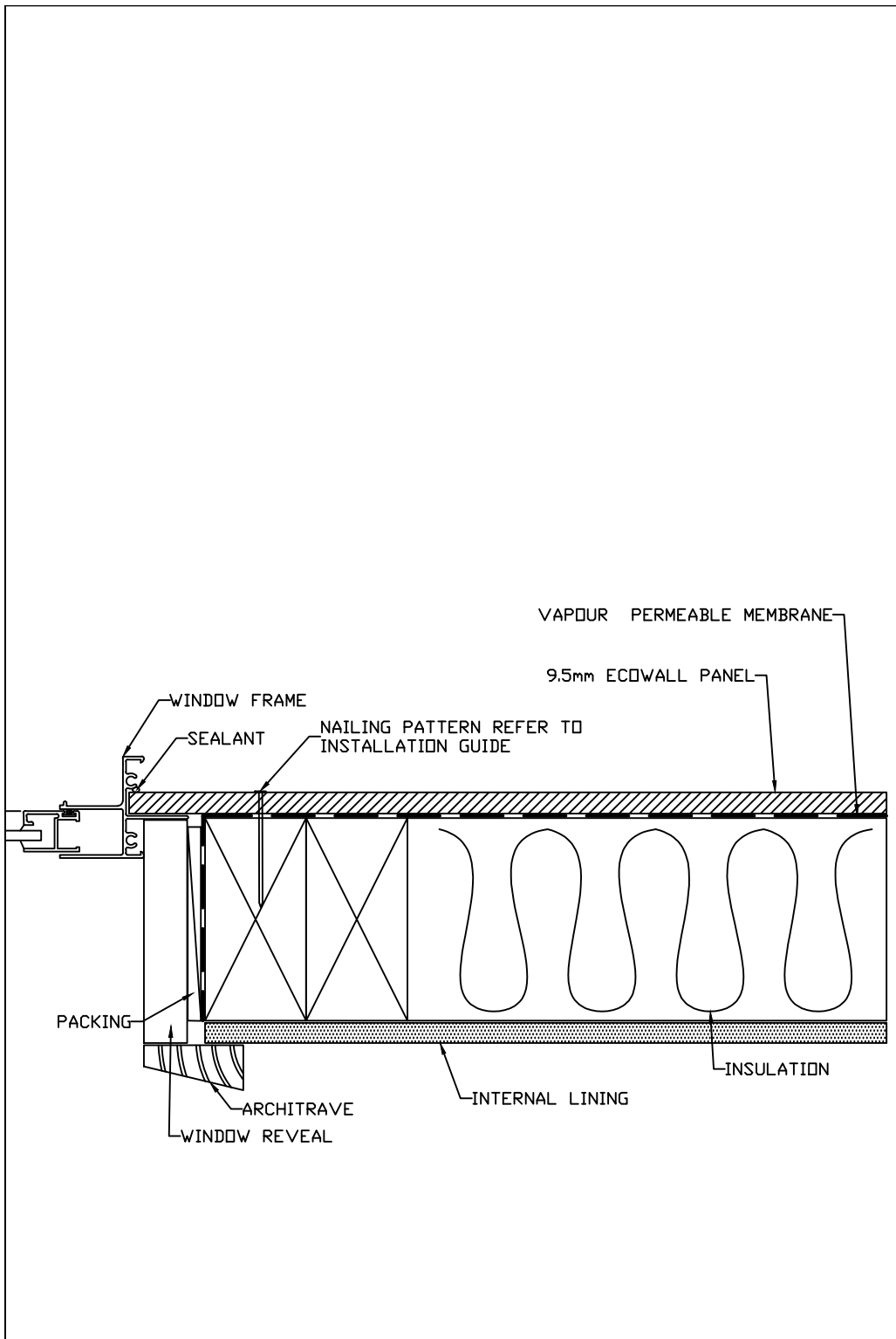

WINDOW JAMB DETAIL

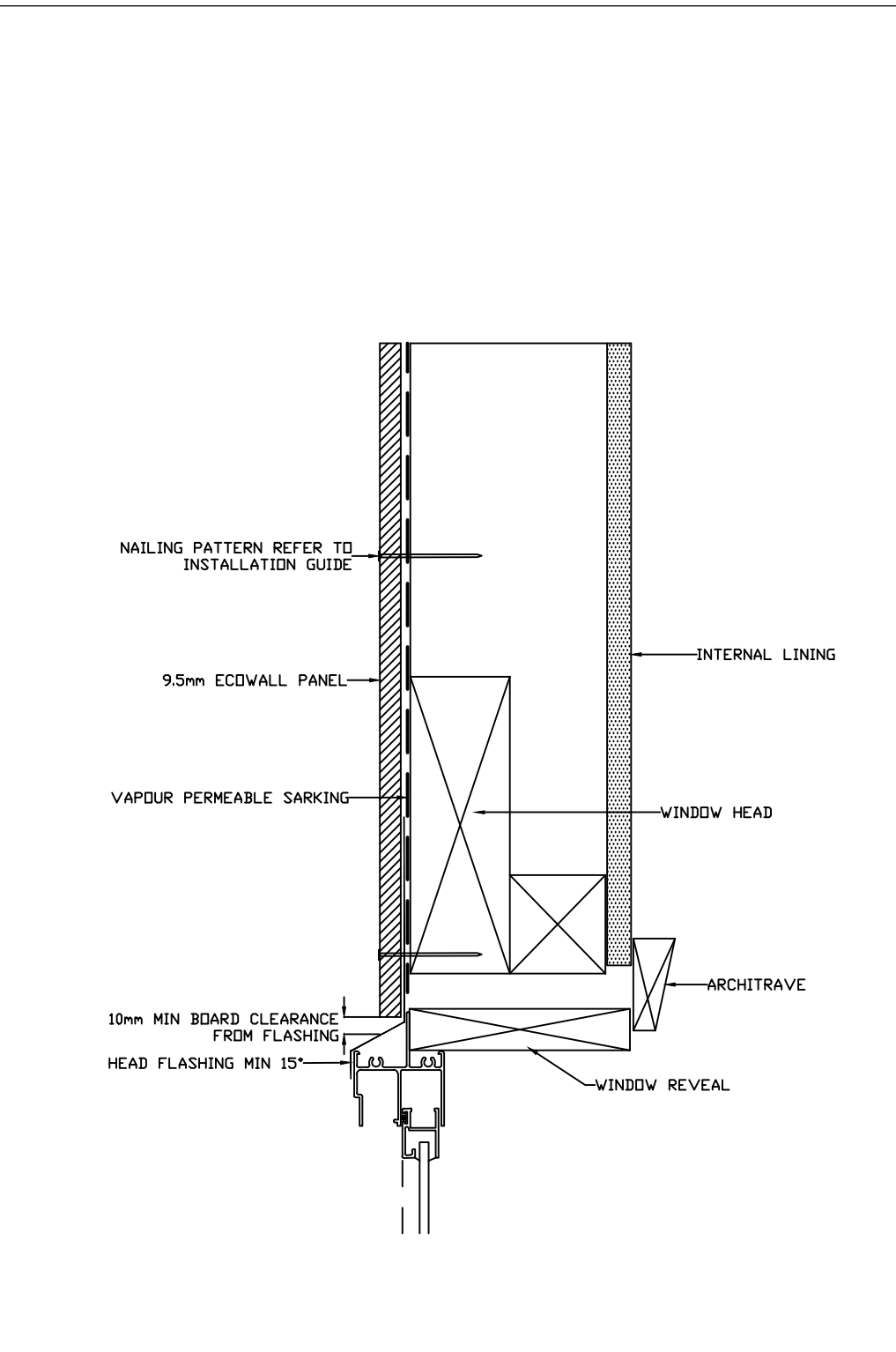

WINDOW HEAD DETAIL

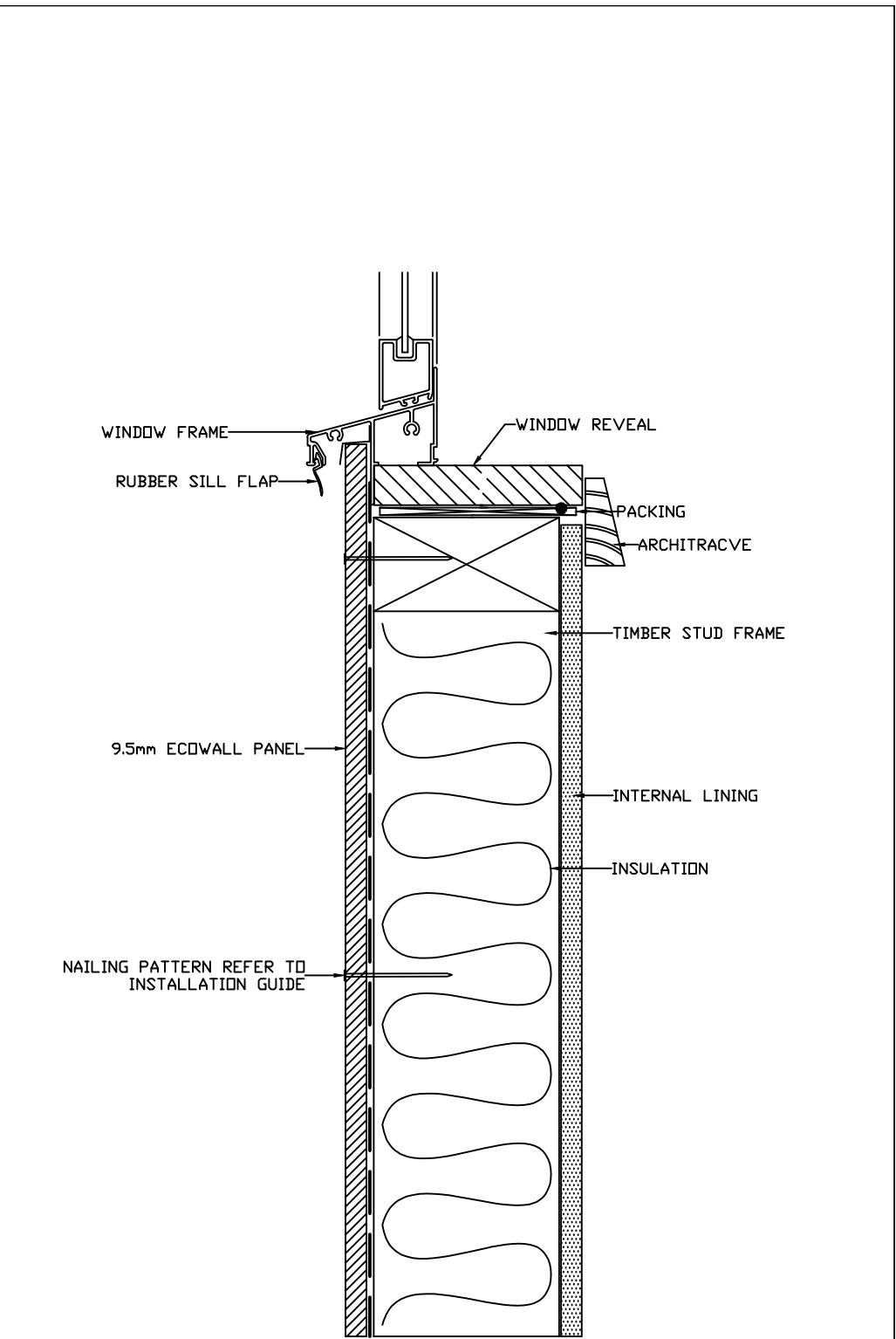

WINDOW SILL DETAIL

|  |   |                      |                             |                                 |                          |                                    |                       |
|--|---|----------------------|-----------------------------|---------------------------------|--------------------------|------------------------------------|-----------------------|
|  | DRAWING NAME:<br><b>DIRECT FIX INSTALLATION - ECOWALL</b> | SCALE:<br><b>NTS</b> | DRAWN BY:<br><b>A.MOATE</b> | CHECKED BY:<br><b>C.O'NEILL</b> | DATE:<br><b>26.10.17</b> | DRAWING SET No.:<br><b>CD-EW-D</b> | SHT SIZE<br><b>A3</b> |
|--|---|----------------------|-----------------------------|---------------------------------|--------------------------|------------------------------------|-----------------------|

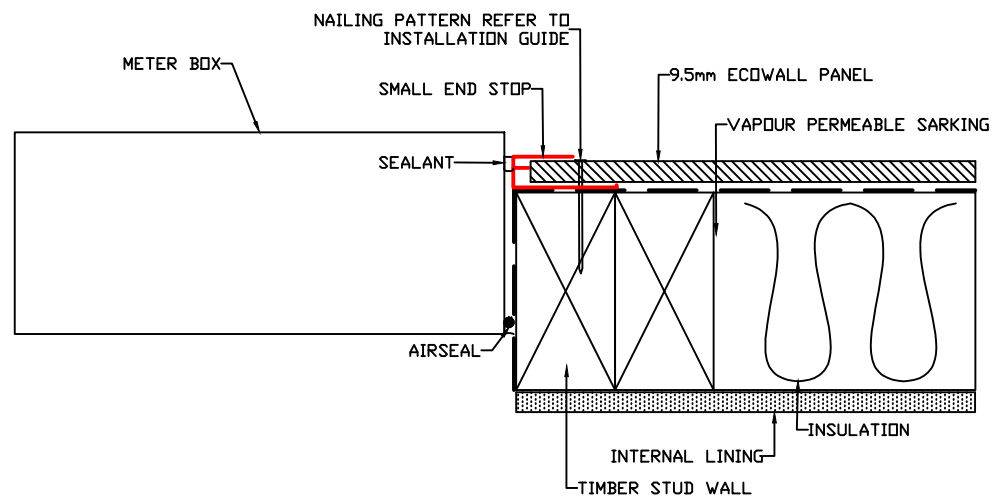

METER BOX JAMB  
DETAIL

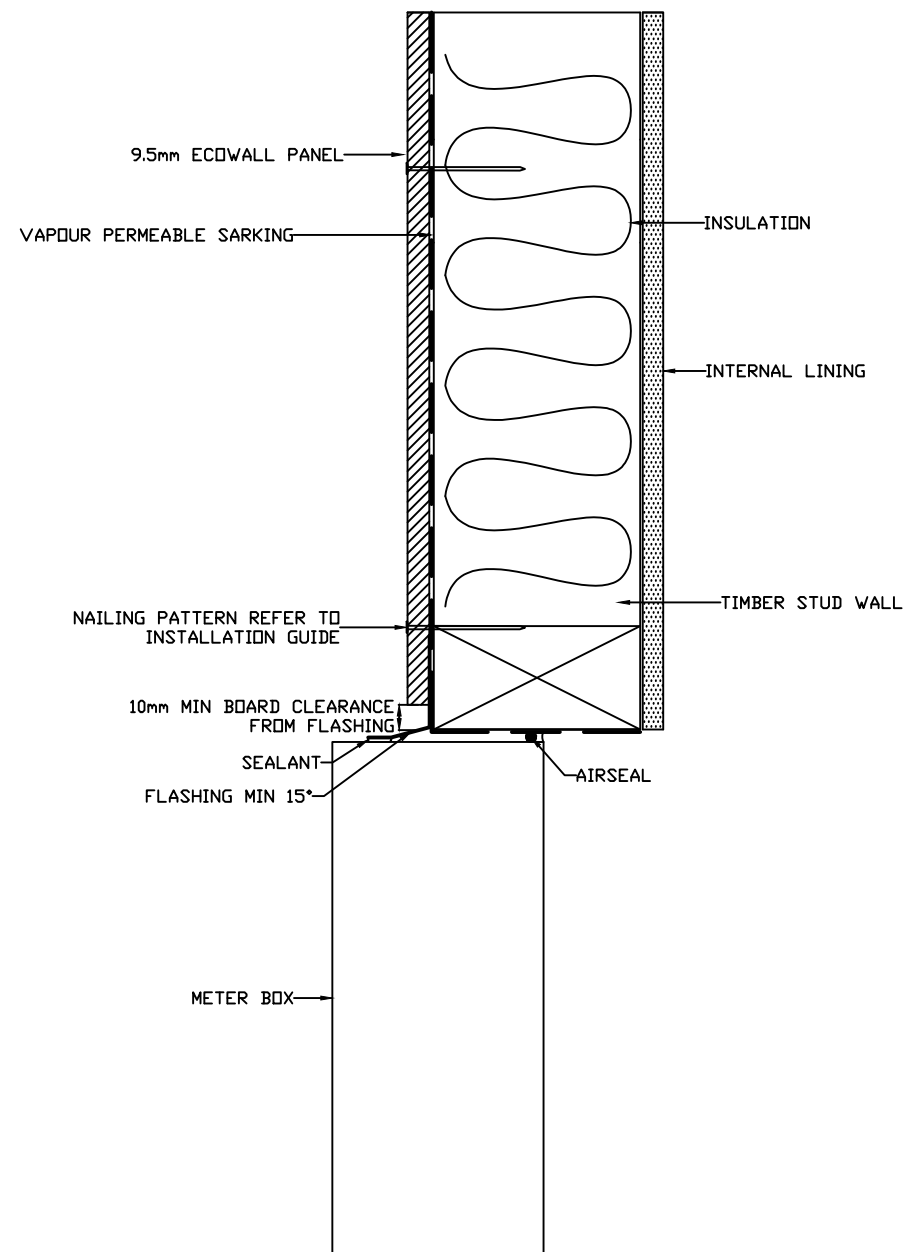

METER BOX HEAD DETAIL

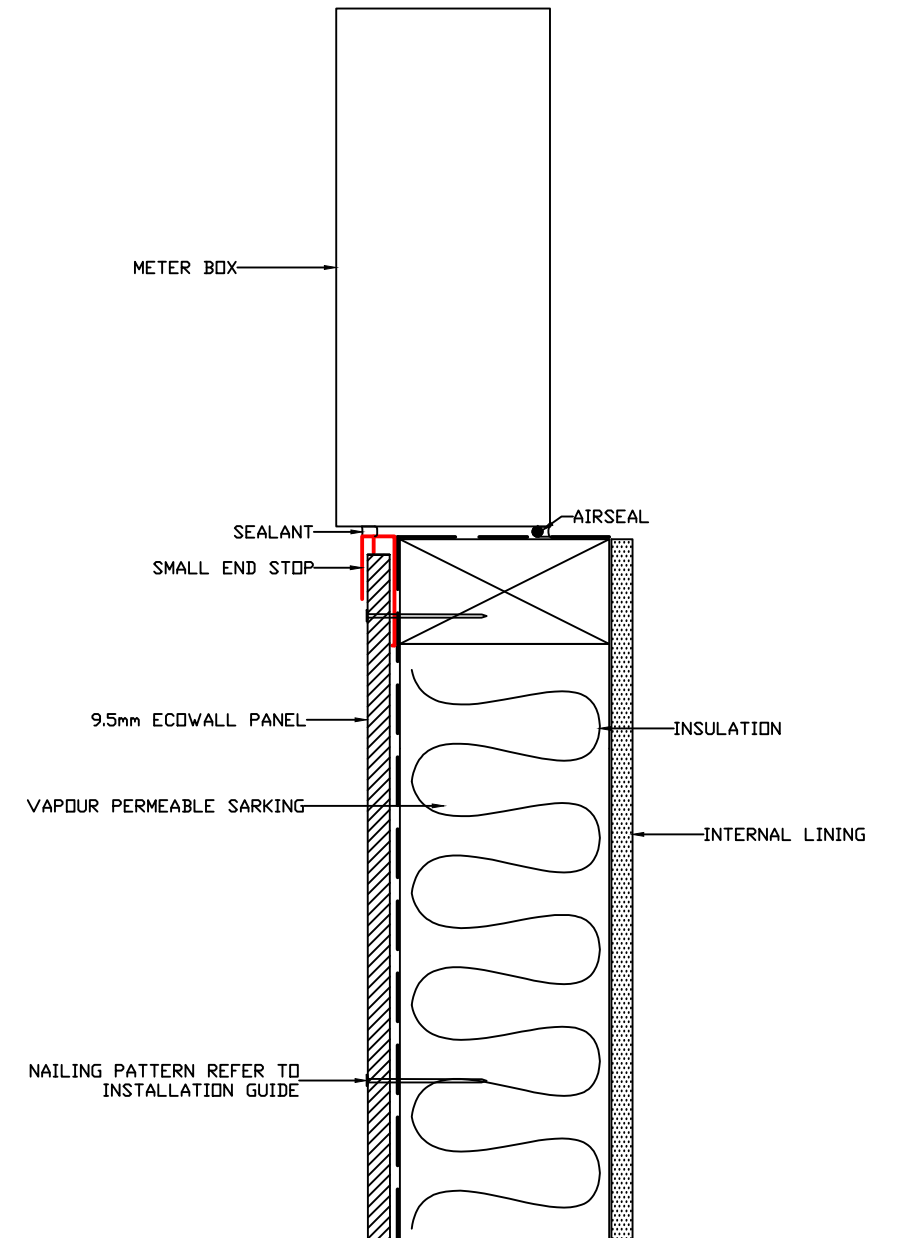

METER BOX SILL DETAIL

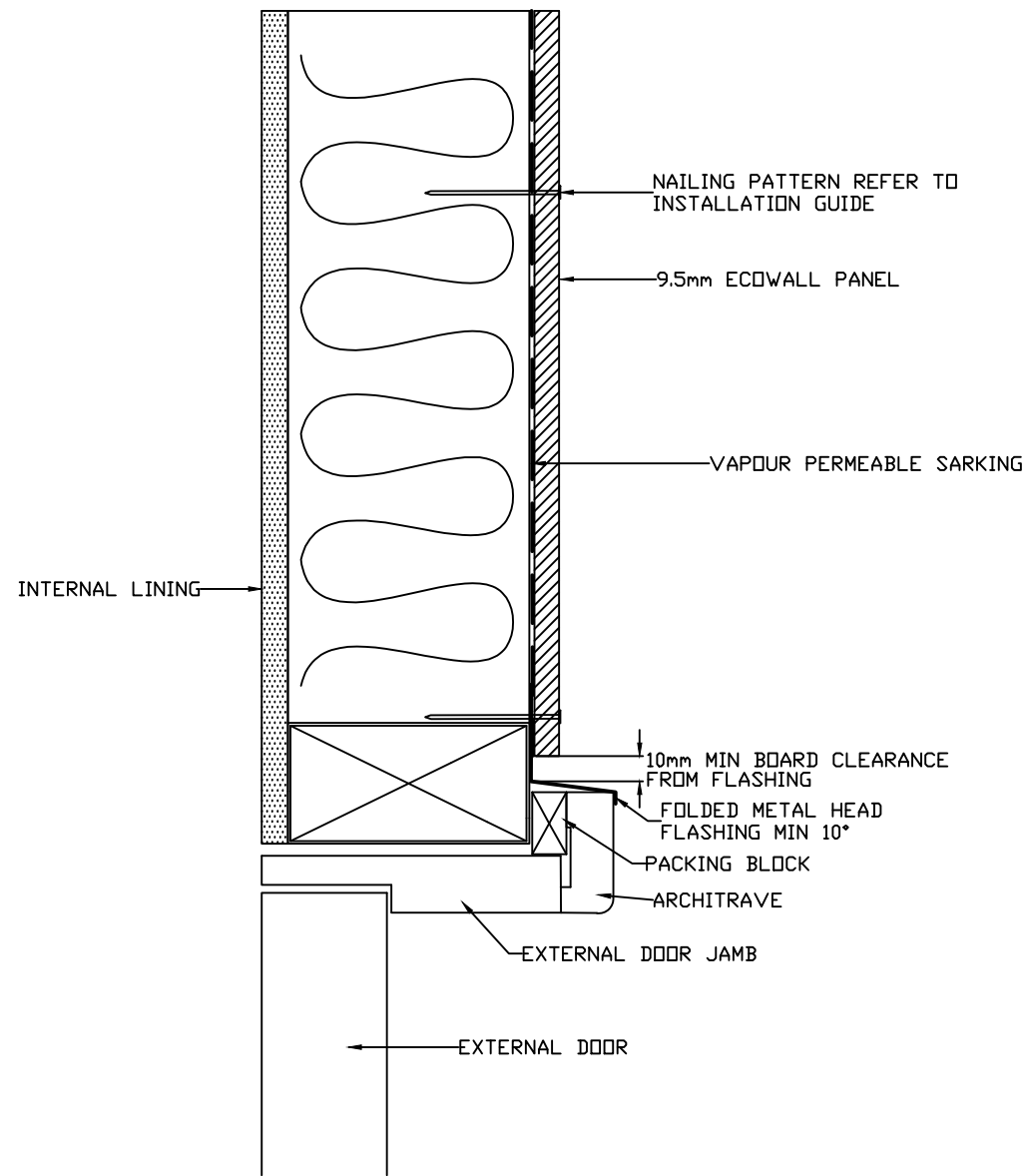

DOOR HEADER DETAIL



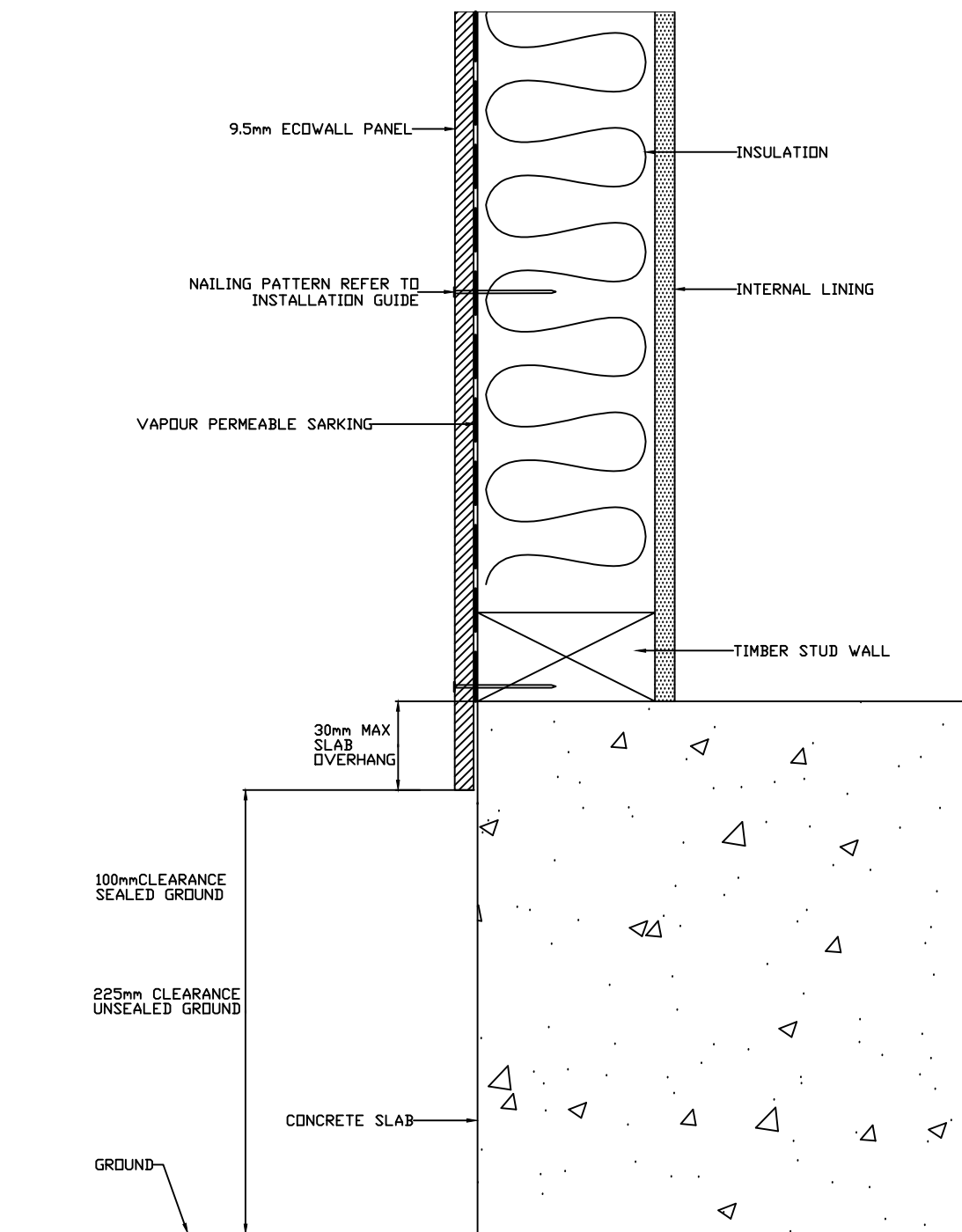

CONCRETE SLAB  
GROUND CLEARANCE DETAIL

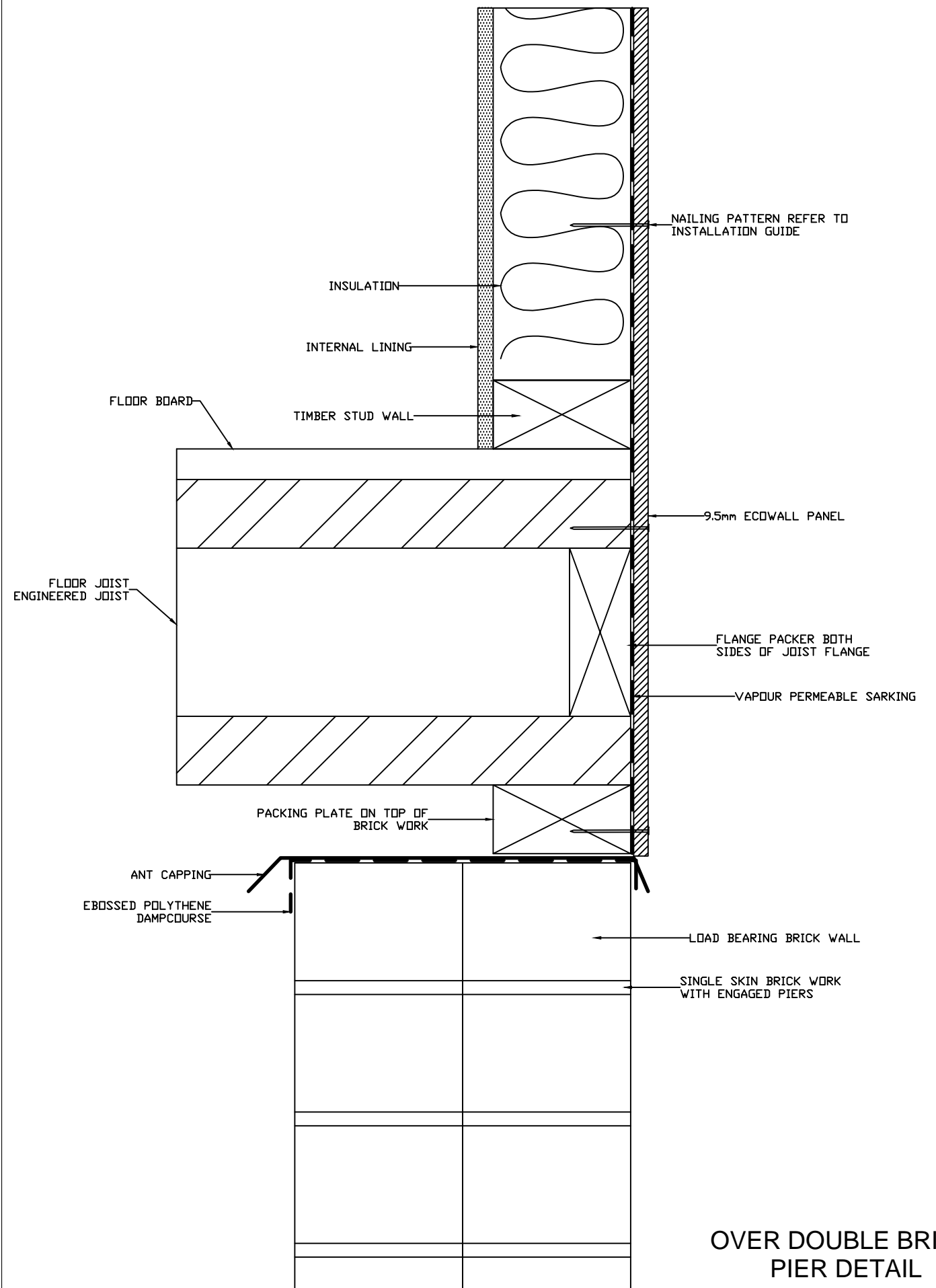

OVER DOUBLE BRICK  
PIER DETAIL

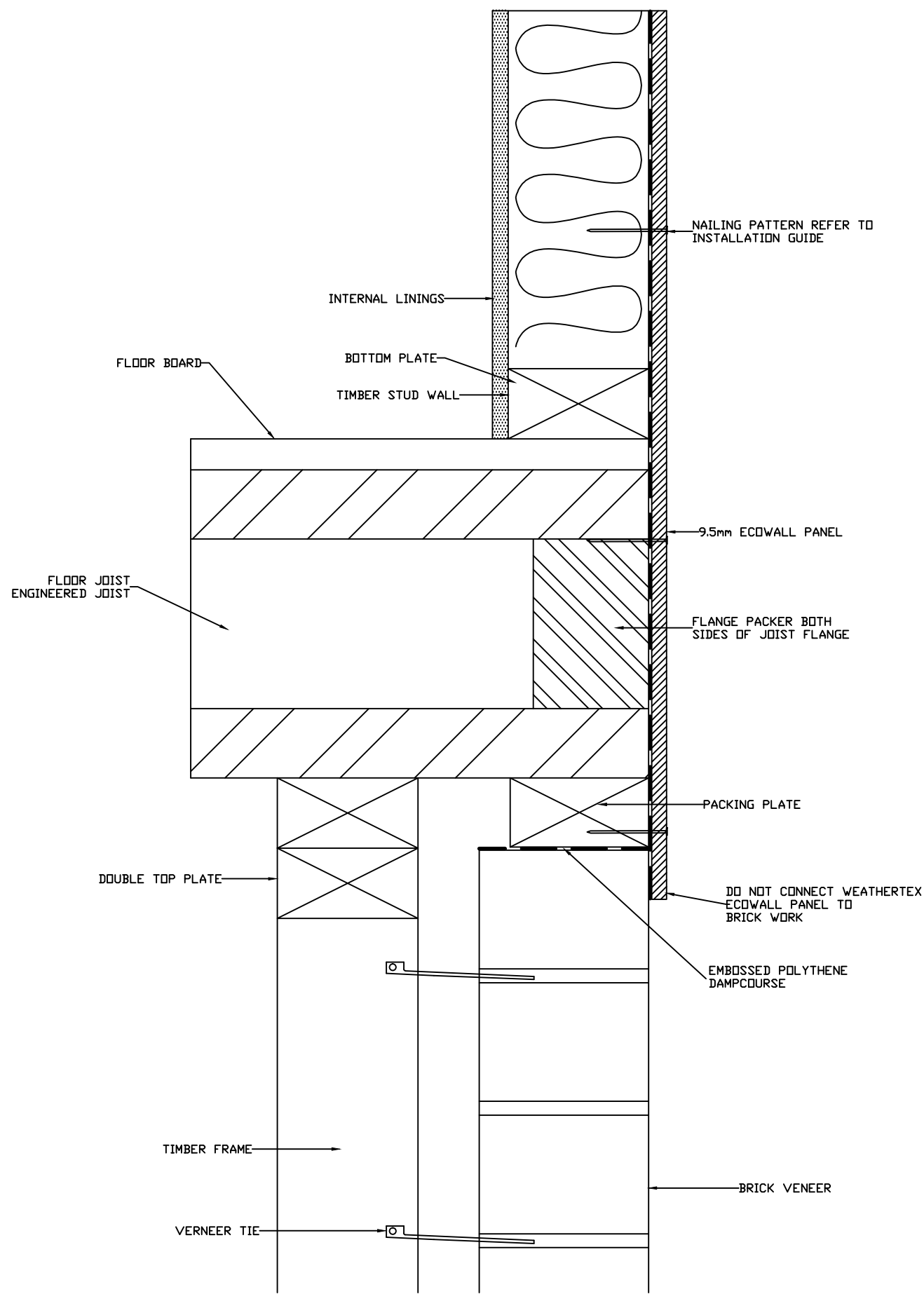

FLUSH WITH BRICK VENEER DETAIL

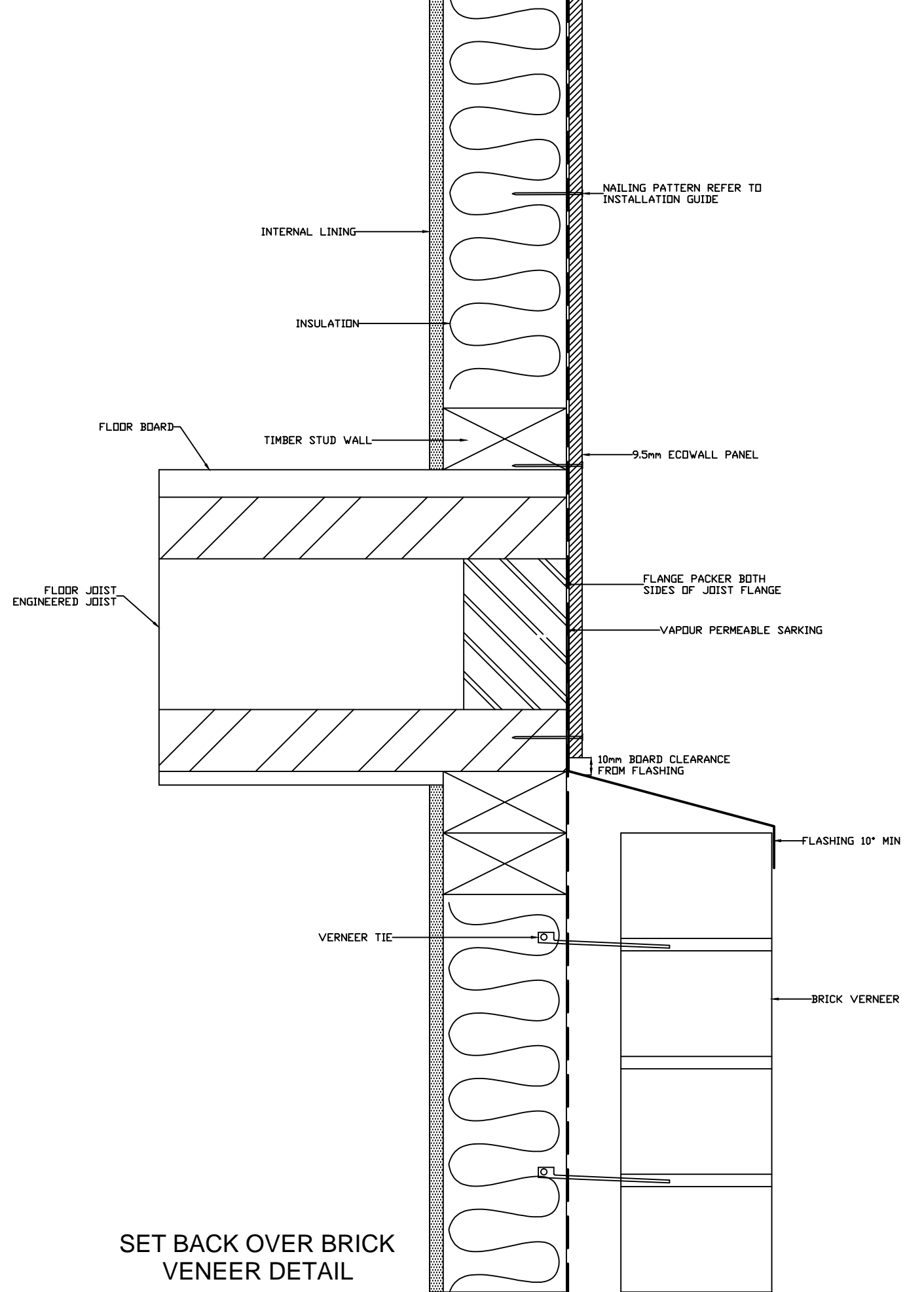

SET BACK OVER BRICK VENEER DETAIL



DRAWING NAME:  
DIRECT FIX INSTALLATION - ECOWALL

SCALE:  
NTS

DRAWN BY:  
A.MOATE

CHECKED BY:  
C.O'NEILL

DATE:  
26.10.17

DRAWING SET No.:  
CD-EW-D

SHT SIZE  
A3

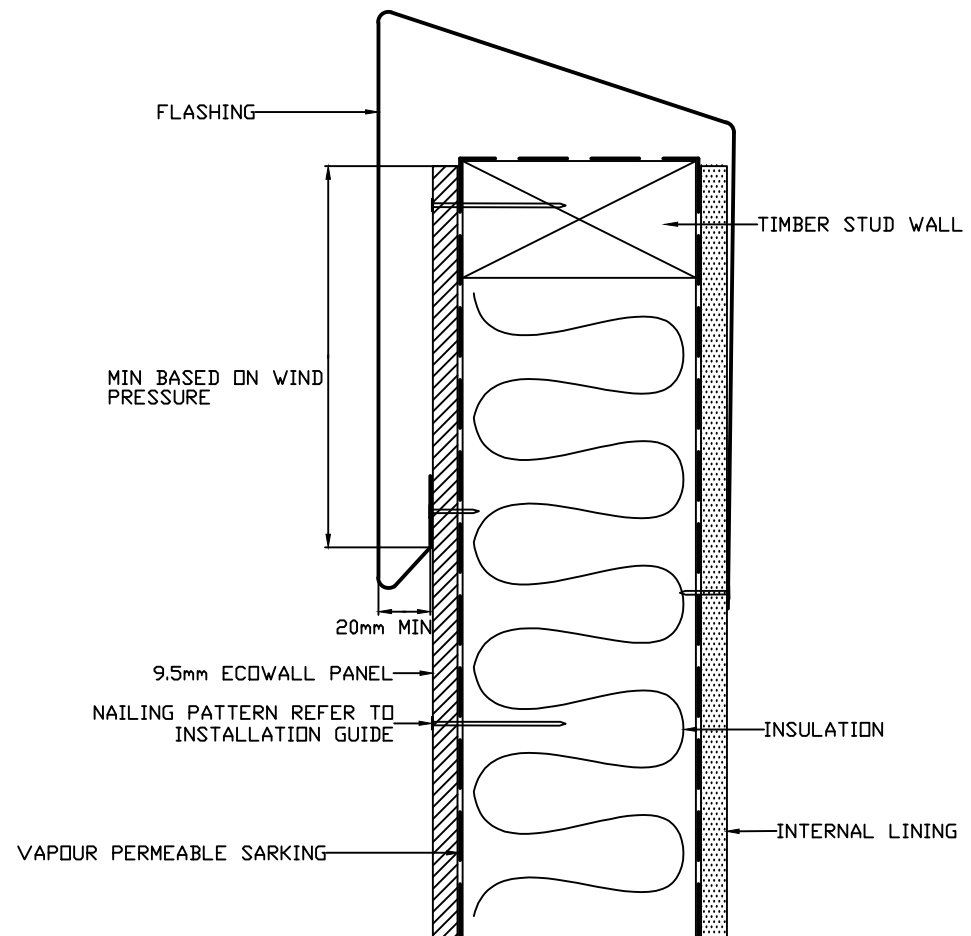

PARAPET DETAIL

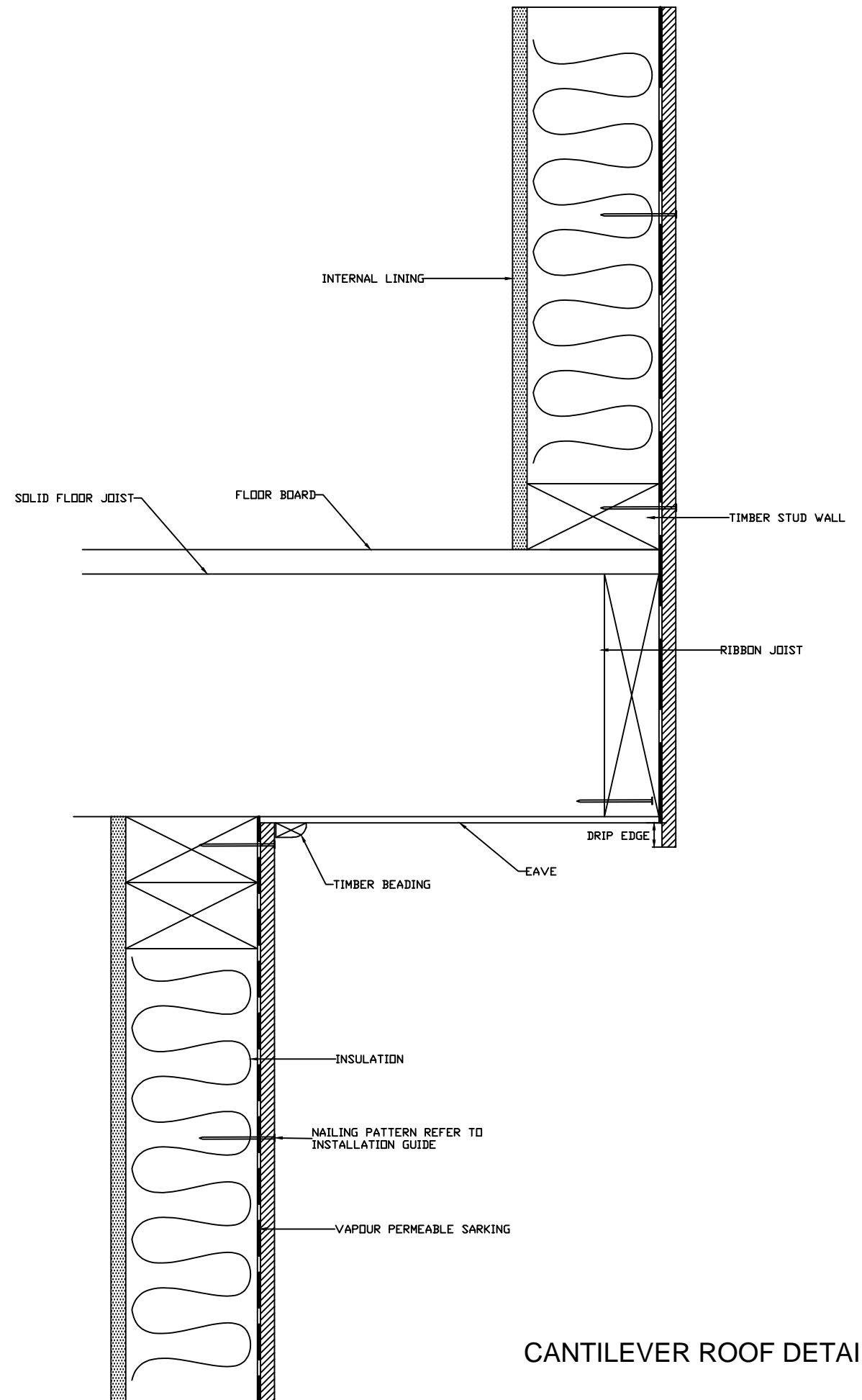

CANTILEVER ROOF DETAIL



DRAWING NAME:  
DIRECT FIX INSTALLATION - ECOWALL

SCALE:  
NTS

DRAWN BY:  
A.MOATE

CHECKED BY:  
C.O'NEILL

DATE:  
26.10.17

DRAWING SET No.:  
CD-EW-D

SHT SIZE  
A3

ROOF CLEARANCE DETAIL

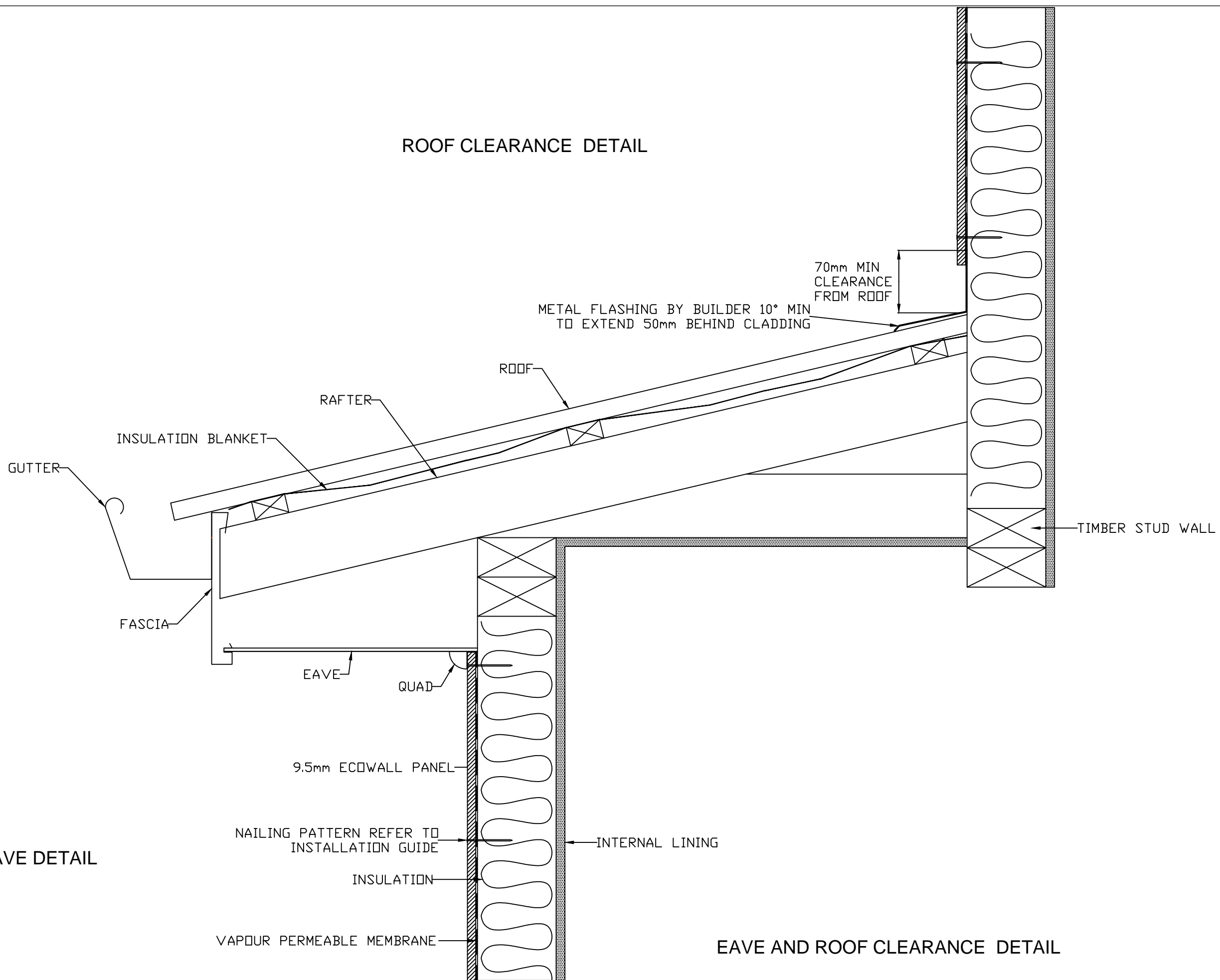

EAVE DETAIL

EAVE AND ROOF CLEARANCE DETAIL

|  |  |               |                      |                          |                   |                             |                |
|--|--|---------------|----------------------|--------------------------|-------------------|-----------------------------|----------------|
|  | DRAWING NAME:<br>DIRECT FIX INSTALLATION - ECOWALL | SCALE:<br>NTS | DRAWN BY:<br>A.MOATE | CHECKED BY:<br>C.O'NEILL | DATE:<br>26.10.17 | DRAWING SET No.:<br>CD-EW-D | SHT SIZE<br>A3 |
|--|--|---------------|----------------------|--------------------------|-------------------|-----------------------------|----------------|

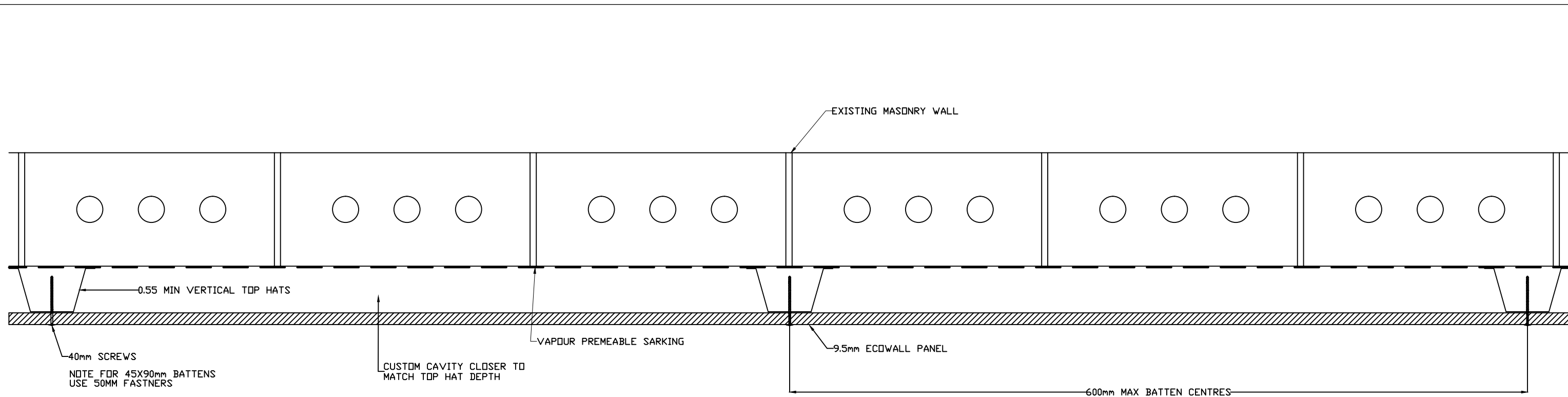

**CLADDING OVER MASONRY WITH  
METAL TOPHATS DETAIL**

NOTE: VERTICAL BATTENS ONLY

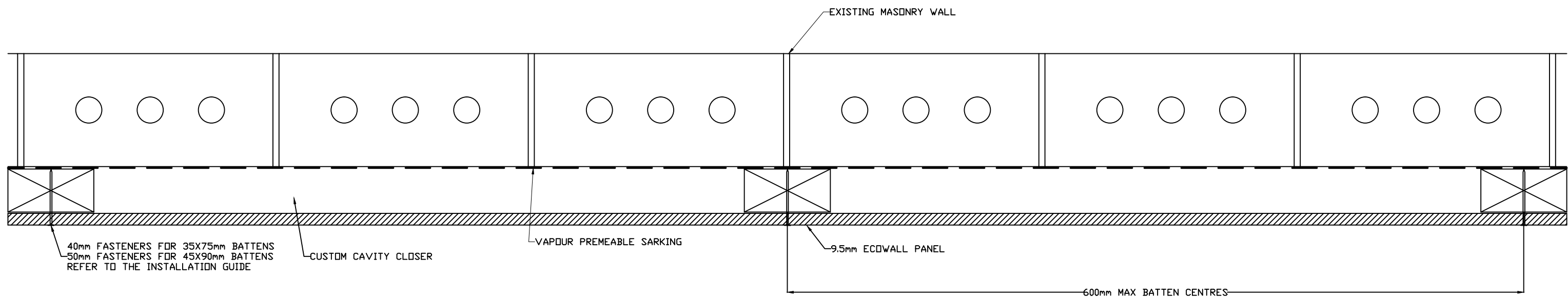

**CLADDING OVER BRICK WITH  
TIMBER BATTEN DETAIL**

NOTE: VERTICAL BATTENS ONLY